



25  
YEARS OF MANUFACTURING  
EXCELLENCE

Experience The  
Excellence

COLLECTION 2020-21



Modern

Handicraft

When it's about pure trust and accountability,  
a finest handcrafted skill is required.

*Wall Hung*

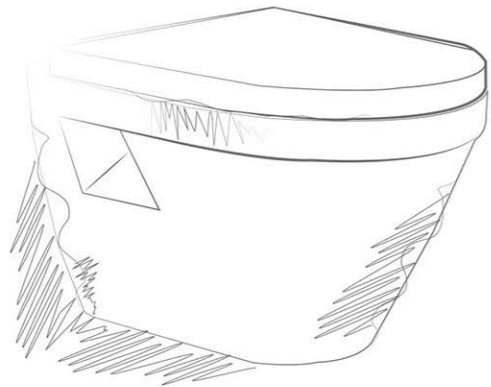

*One Piece Closet*



*Table Top*

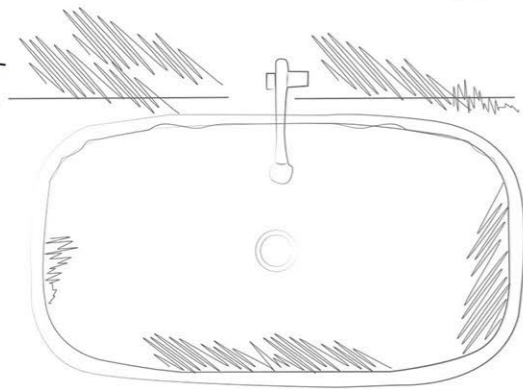

—  
*trust our*  
Handcrafted Luxury

## DESIGN & STYLE

### Innovative and Original Design,

When innovation and creativity inspired by imagination, we craft a unique and special product that suits in your bath space.

We offer rapid 3d technology and latest software we can able to covert your vision into stylish reality with wide range of styles sanitary ware products that crafted with experienced person. Give taste of elegant designs to your bath space.



P R E M I U M  
S A N I T A R Y W A R E

Connecting dots is the way of creating successful and artistic product that convert imagination to reality with latest 3d software we create an object exactly as we wanted.



As we get the raw format of our sanitary ware products with the help of software technology we can easily identify which material need to give exact look as need for bath space design.



It's time our crafters give the final appearance of our sanitary ware products to represent our iconic product to rest of the world.



# EVOLUTION

## Updated ergonomics

When we enter in 21st century a lot happens around the globe. People start changing their lifestyles & their needs. So we also change our mindset and start producing sanitary ware products that meets the need of today's generation .

As the genes changes, we also make changes in our products that suits their moods with accurate research and information we highly developed a product that is as comfortable as they wanted.

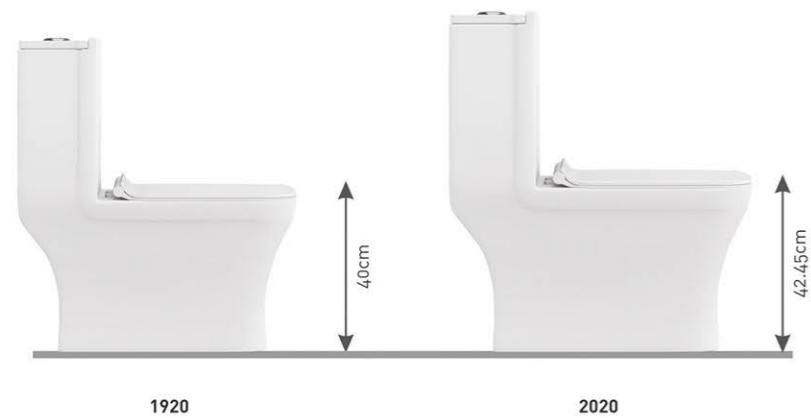

## Comfort Height

As a decade passed away changes in the human body were also evolved in the timely manner with the help of research institute, we make sure that all the sanitary ware products are produce with the comfort level of the human body.

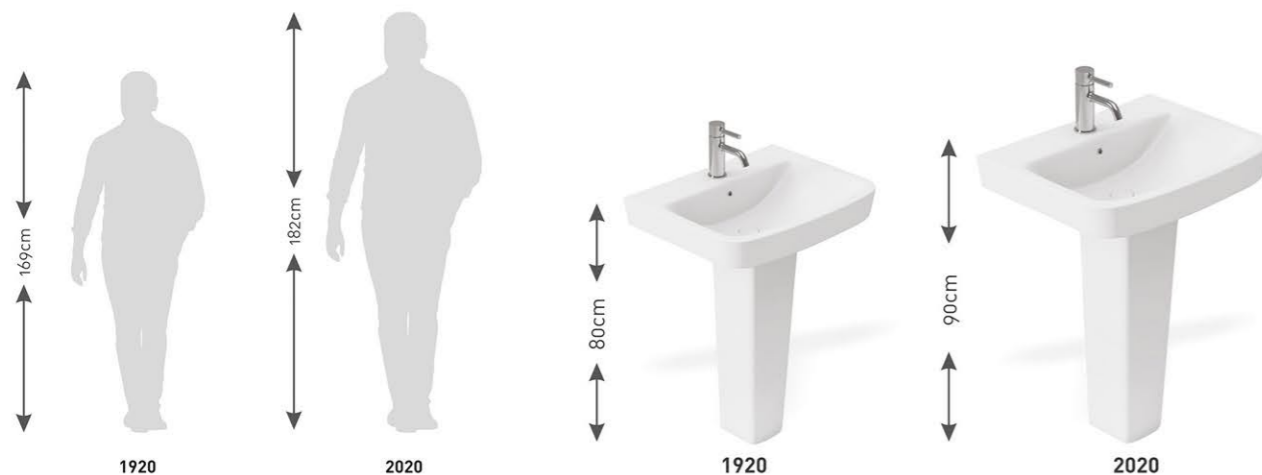

# HIDDEN FIXATION

## Hidden fixation system

Fully compatible with our installation systems, our sanitary ware products are secured to a robust steel frame installed behind the wall, leaving a seamless and elegant bathroom scheme with seamless installation using the hidden fixation system, fix any sanitary ware products on a wall in a faster way, in less time and easily

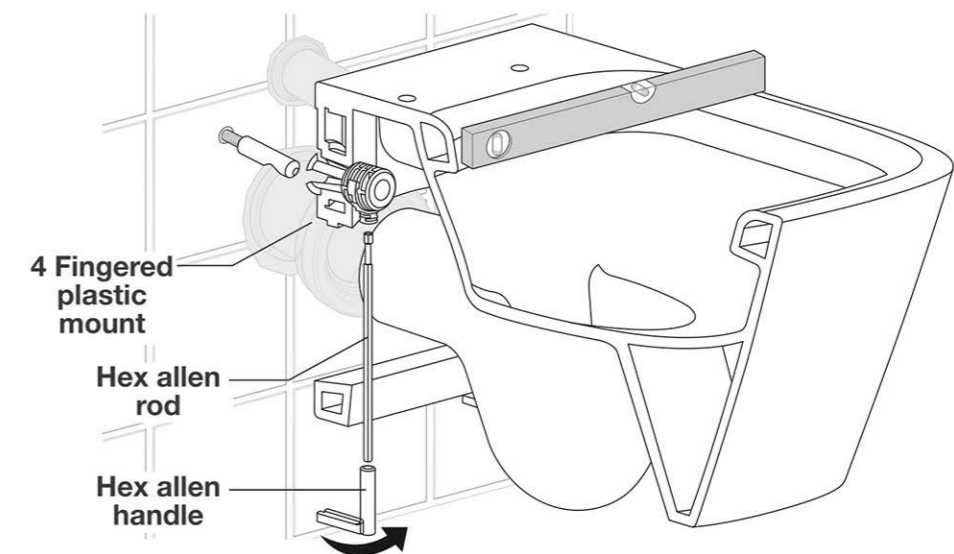
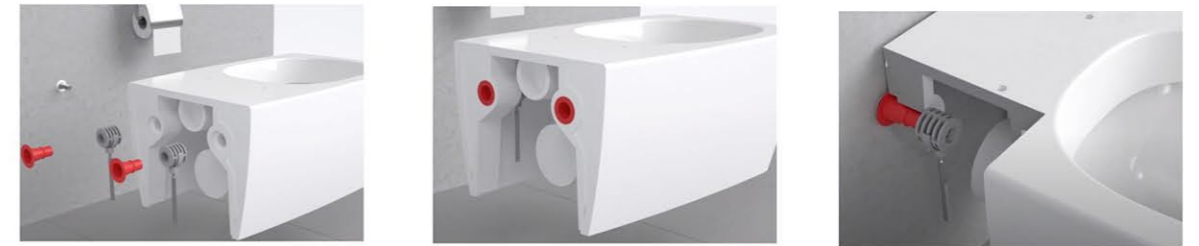

## WATER SAVING

### Can we save water in your bathrooms

Water is a precious element to our life. Our aim is to get maximum cleaning with less water. In our new research & development we successfully use less water that give more cleanness in our sanitary were product.

With this development we can save maximum water for future generations.

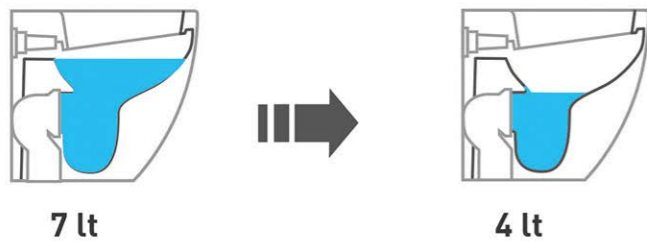

## RIMLESS

### The ultimate rimless technology for you bathroom

A rimless toilet made for significantly easier cleaning and a clear improvement in hygiene.

There is no build-up of bacteria and no possibility for limescale to lurk. The Rimless technology ensures quintessential hygiene with effective flushing that offers an efficient solution ensuring that the entire inner surface is rinsed throughout the flushing process.

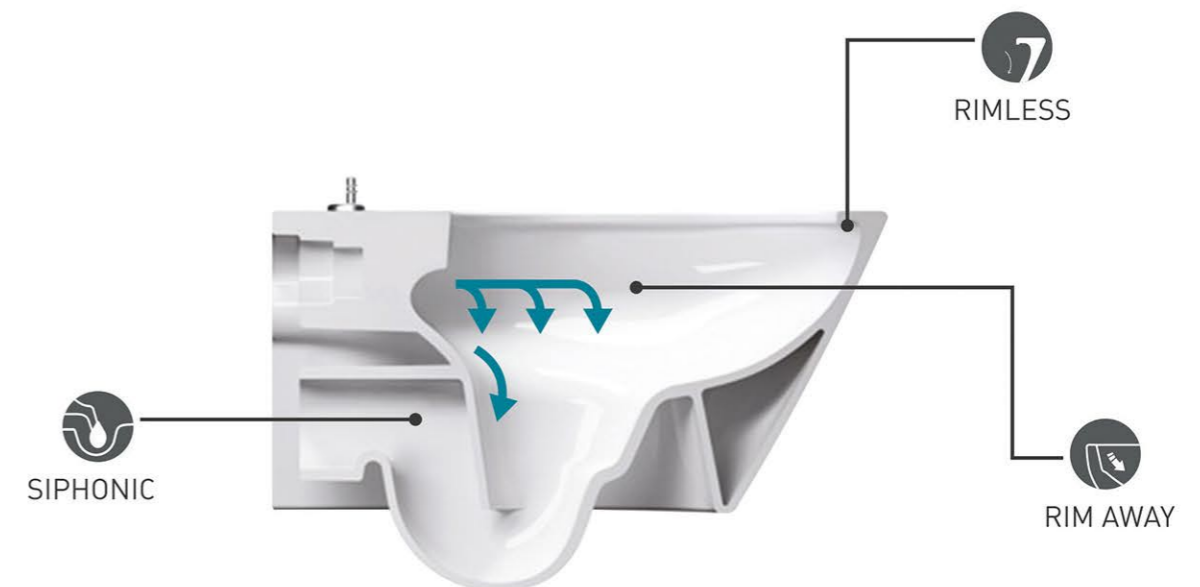

# TORNADO FLUSH

## What is tornado flush?

Tornado Flush is an integral feature in new toilet. Instead of letting water pour down from the rim as in a traditional flush, the Tornado Flush projects three powerful jets of water from inside the bowl. This motion creates a whirlpool effect that cleans the entire surface.

It has been engineered so that the flushing water comes out at an angle creating a vortex or tornado-like suction. This provides a stronger force when flushing leaving you with a clean toilet every time

## THE POWERFUL TOILET FLUSH



### TORNADO FLUSH

When the water flows out the holes under the rim of the pan it comes out on an angle, not straight down. This allows the water to create a vortex inside the toilet pan. It does two things; it creates a far more powerful flush because of the force the spiraling water creates & it also washes the inside of the pan much better than any other flushing mechanism.

Need less water,  
Get more clean



Cleanness in every  
edge of the corner

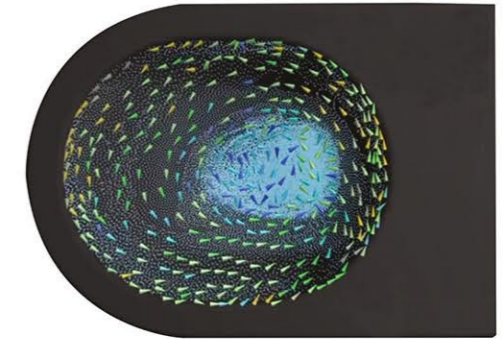



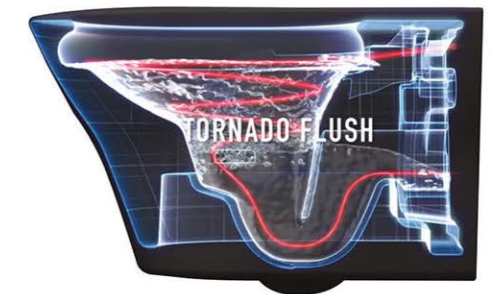

Today's innovation for  
tomorrow's world

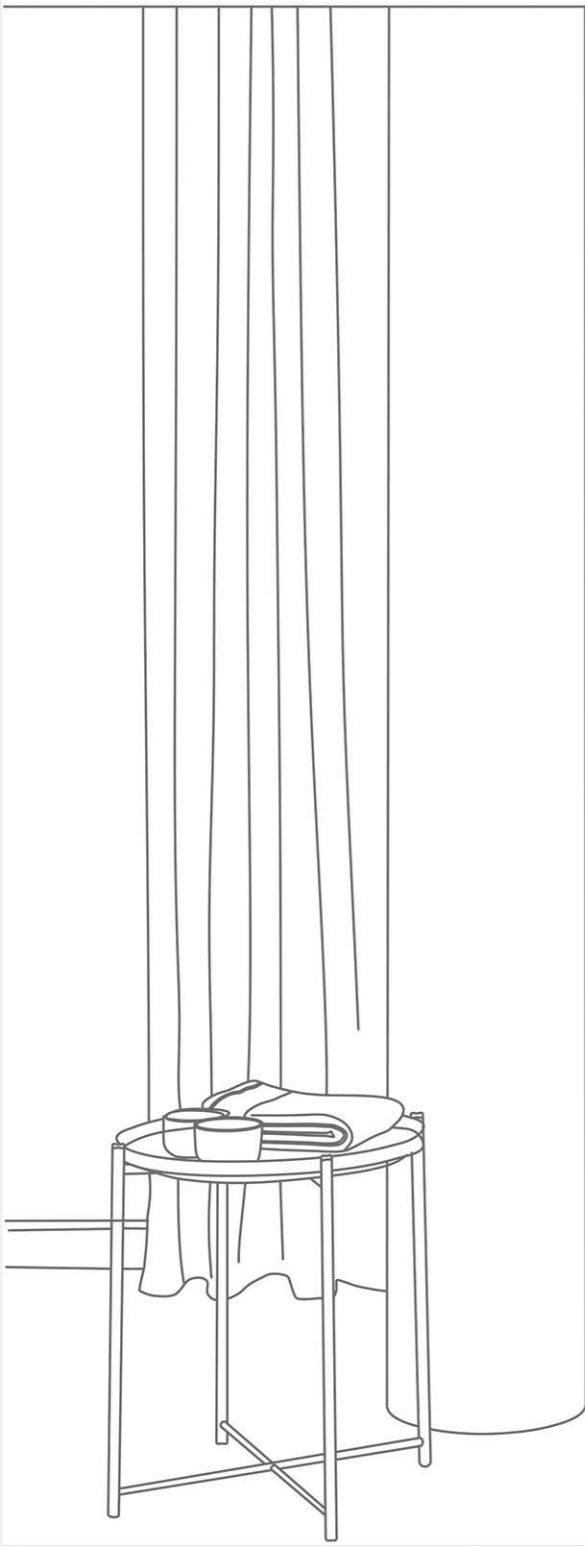

# OUR COLLECTION

We create leading-edge products, by combining innovative solutions and excellence in terms of aesthetics and functionality. Our range is developed by soft molded shapes that slenders its impressive volumes. The products have easily adoptable to modern and classic ambience and have lovely ceramic gloss finishes.



-  Use of eco-friendly natural gas residues for better shine and luster
-  Production process according to ISI, ISO European standard
-  High-tempered firing with hygiene-friendly production process

01 / AQU SHADES

49 / WALL HUNG CLOSET

139 / WASH BASIN

171 / HALF & FULL PEDESTAL

199 / FLOOR MOUNT EWC WATER CLOSET & ORRISA PAN

17 / ONE PIECE CLOSET

95 / TABLE TOP BASIN

161 / ONE PIECE BASIN

193 / UNDER COUNTER BASIN

215 / URINAL

AVAILABLE COLOURS :  WHITE  IVORY

-  Each product radiates glossiness and whiteness
-  Use of finest raw materials - Purified, tested and certified by R&D
-  Use of advanced German technology with fully computerized controlled Shuttled Kiin
-  Water-saving flushing system with 7/4-litre knobs
-  Soft closing seat cover



## MATTSeries

*Color has a power  
which directly  
influences the  
soul and fill  
the lives into  
the world.*

---

*A living element  
that drive  
creativity and  
innovation  
of living style*





# ROYAL BLUE



**COMPACT**

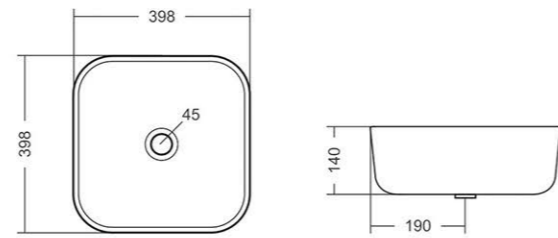
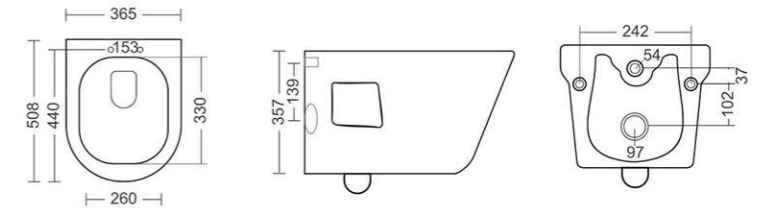

TABLE TOP BASIN  
L398, W398, H140MM



**RIGA**



WALL HUNG CLOSET  
RIMLESS  
L508, W365, H357MM





**MOUNT PEARL**



**COMPACT**

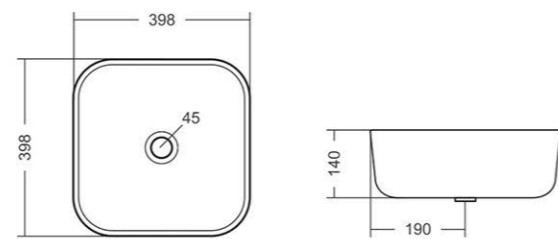
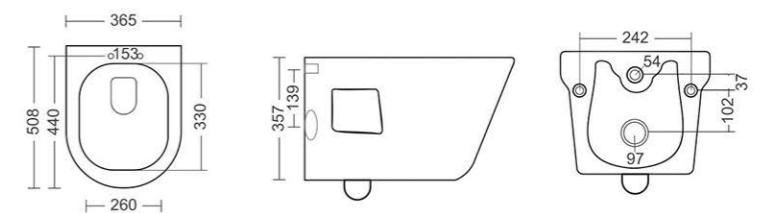

TABLE TOP BASIN  
L398, W398, H140MM



**RIGA**



WALL HUNG CLOSET  
RIMLESS  
L508, W365, H357MM



MATT WHITE



**COMPACT**

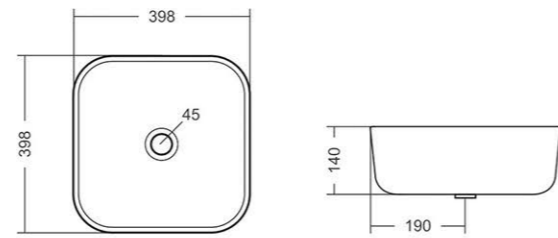
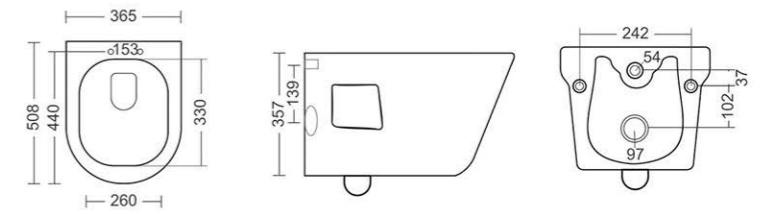

TABLE TOP BASIN  
L398, W398, H140MM



**RIGA**



WALL HUNG CLOSET  
RIMLESS  
L508, W365, H357MM





**LIGHT PINK**



**COMPACT**

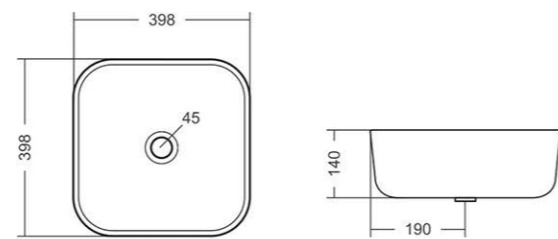
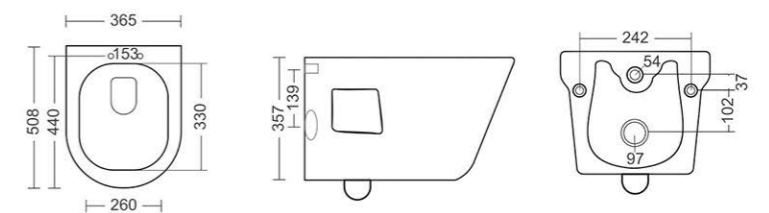

TABLE TOP BASIN  
L398, W398, H140MM



**RIGA**



WALL HUNG CLOSET  
RIMLESS  
L508, W365, H357MM



# LIGHT CREAM NATURE



**COMPACT**

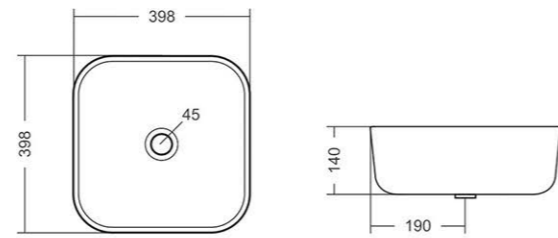
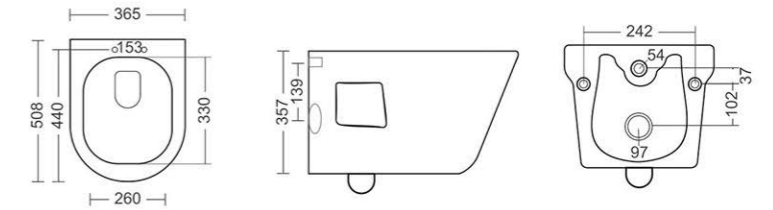

TABLE TOP BASIN  
L398, W398, H140MM



**RIGA**



WALL HUNG CLOSET  
RIMLESS  
L508, W365, H357MM





**BLACK PEARL**



**COMPACT**

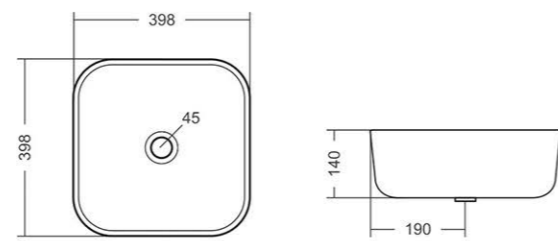
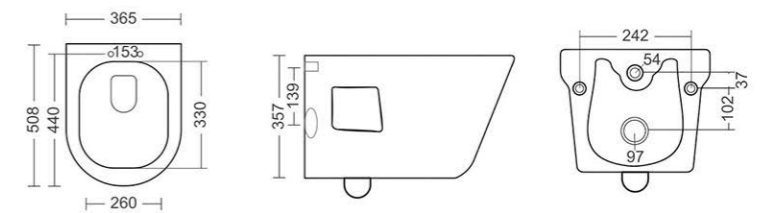

TABLE TOP BASIN  
L398, W398, H140MM



**RIGA**



WALL HUNG CLOSET  
RIMLESS  
L508, W365, H357MM

**7** RIMLESS

# ASIAN PEACOCK



**COMPACT**

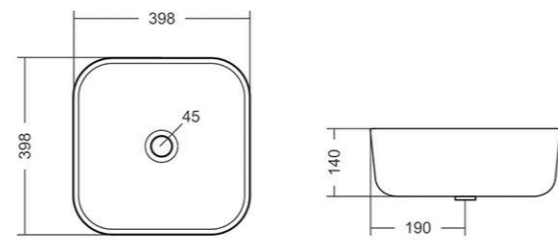
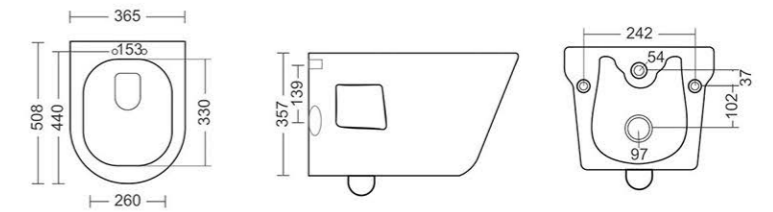

TABLE TOP BASIN  
L398, W398, H140MM



**RIGA**



WALL HUNG CLOSET  
RIMLESS  
L508, W365, H357MM





one piece  
closet







## 2001

ONE PIECE CLOSET  
WASH DOWN FLUSHING

S-TRAP WALL DIST. 225MM

L686, W370, H700MM

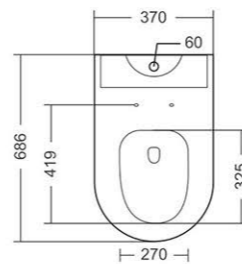
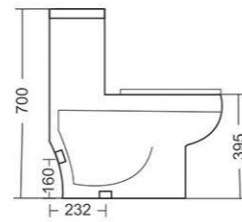

—  
—  
Evoke the beauty  
of arts





Become center  
of tomorrow's  
world

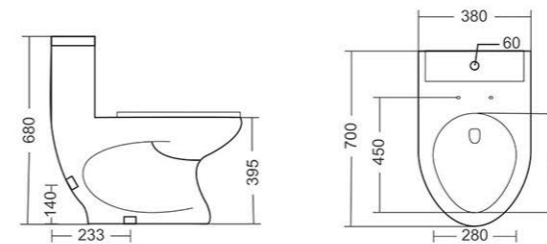

**2002**

ONE PIECE CLOSET  
WASH DOWN FLUSHING

S-TRAP WALL DIST. 225MM

L700, W380, H680MM



### 2003

ONE PIECE CLOSET  
WASH DOWN FLUSHING

S-TRAP WALL DIST. 225MM

L662, W355, H725MM

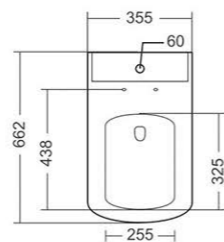
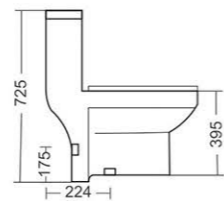

Linear and  
minimalist design





Perfectly blend  
with the simplicity

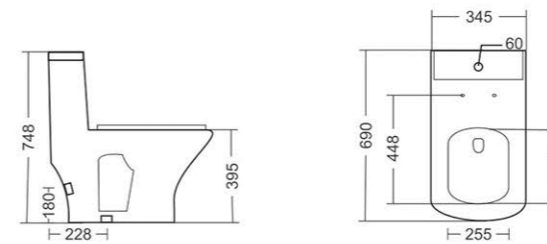

**2004**

ONE PIECE CLOSET  
WASH DOWN FLUSHING

S-TRAP WALL DIST. 225MM

L690, W345, H748MM



## 2005

ONE PIECE CLOSET  
WASH DOWN FLUSHING

S-TRAP WALL DIST. 225MM

L700, W375, H675MM

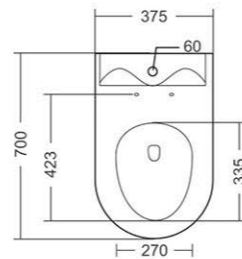
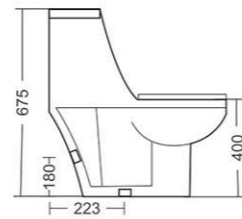

Expressed through  
the Luxury





With simply  
look and elegance

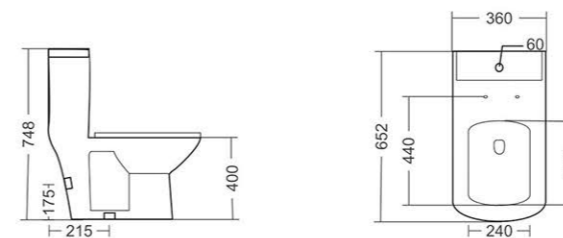

**2006**

ONE PIECE CLOSET  
WASH DOWN FLUSHING

S-TRAP WALL DIST. 225MM

L652, W360, H748MM



## 2007

ONE PIECE CLOSET  
WASH DOWN FLUSHING

S-TRAP WALL DIST. 100MM /255MM

L645, W345, H680MM

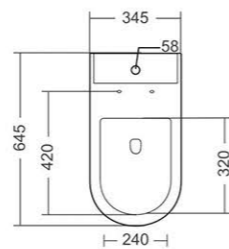
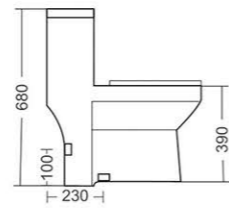

Charming stylistic  
detailing





Feel immersive  
experience

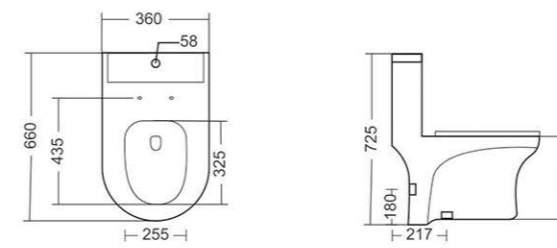

**2008**

ONE PIECE CLOSET  
WASH DOWN FLUSHING

S-TRAP WALL DIST. 225MM

L660, W360, H725MM





## 2009

ONE PIECE CLOSET  
SIPHONIC FLUSHING

S-TRAP WALL DIST. 225MM

L675, W365, H760MM

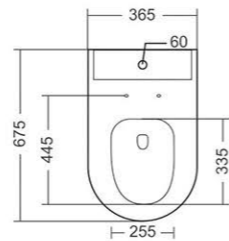
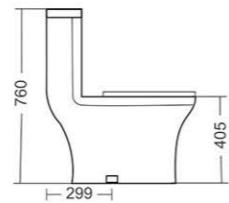

Pure without  
any interruptions





An elegant  
voyage



**3L** 3 LITER  
FLUSHING

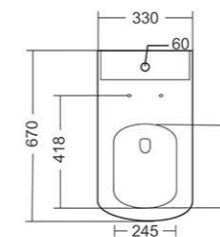
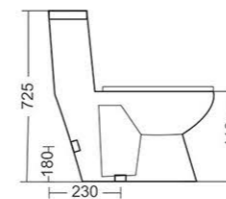

**2010**

ONE PIECE CLOSET  
WASH DOWN FLUSHING  
3 LITER FLUSHING

S-TRAP WALL DIST. 225MM

L670, W330, H725MM



## 2011

ONE PIECE CLOSET  
WASH DOWN FLUSHING  
3 LITER FLUSHING

S-TRAP WALL DIST. 225MM

L655, W350, H740MM

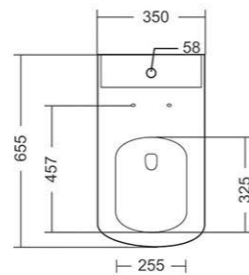
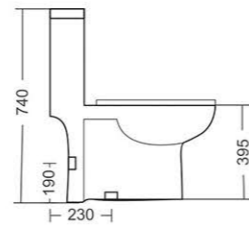

Create embellished  
bath spaces

**3L** 3 LITER  
FLUSHING





Mixture of  
beauty and emotion

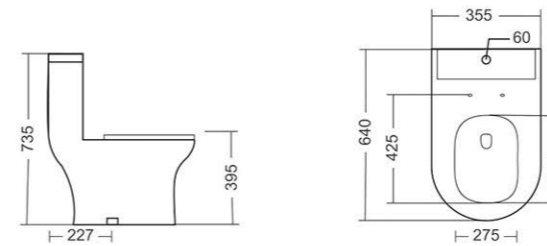

**2012**

ONE PIECE CLOSET  
SIPHONIC FLUSHING

S-TRAP WALL DIST. 225MM / 300MM

L640, W355, H735MM



## 2013

ONE PIECE CLOSET  
SIPHONIC FLUSHING  
4D TECHNOLOGY

S-TRAP DIST. 225MM / 300MM

L645, W353, H740MM

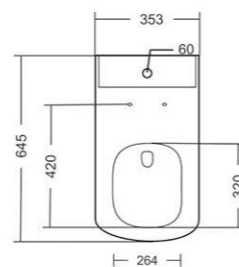
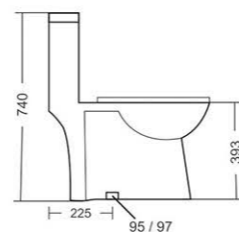

The mark of  
marvelous





Timeless symbol  
of elegance



 SIPHONIC  4D TECHNOLOGY

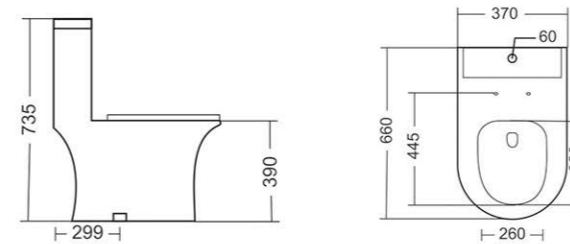

**2014**

ONE PIECE CLOSET  
SIPHONIC FLUSHING  
4D TECHNOLOGY

S-TRAP-225MM / 300MM

L660, W370, H735MM

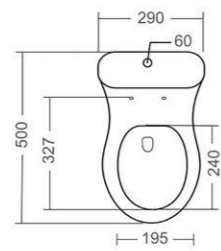
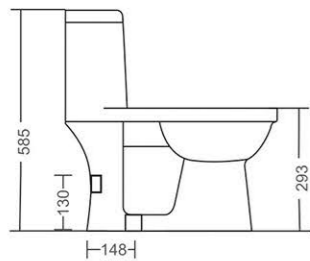

## BABY

ONE PIECE CLOSET  
WASH DOWN FLUSHING

S-TRAP WALL DIST. 225MM / 300MM

L500, W290, H585MM

## PREMIUM SANITARYWARE



GLOSSINESS AND  
WHITENESS

### THE PRODUCT ATTRIBUTES



Resistant to limestone,  
to impact and to abrasion



The integrated process  
of enamel firing ensures  
greater durability of  
the surfaces over time



Easy and quick cleaning



Scratches & Breaks Easily  
Renewable



Each product radiates  
glossiness and whiteness



Water-saving flushing  
system with 7/4-litre knobs



Soft closing seat cover

 **wall hung  
closet**

---







Simplicity in every  
gesture



**7** RIMLESS

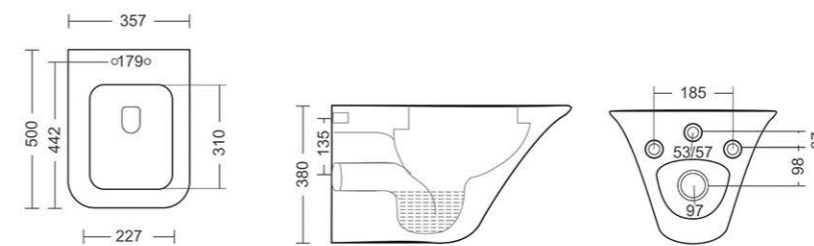

**ASPIRE**

WALL HUNG CLOSET  
RIMLESS

L500, W357, H380MM



## COSMOS

WALL HUNG CLOSET  
RIMLESS

L490, W360, H360MM

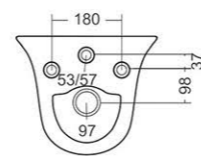
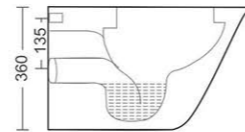
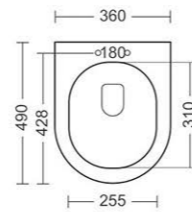

Pleasure of all  
the smoothness





Finest and unique  
design

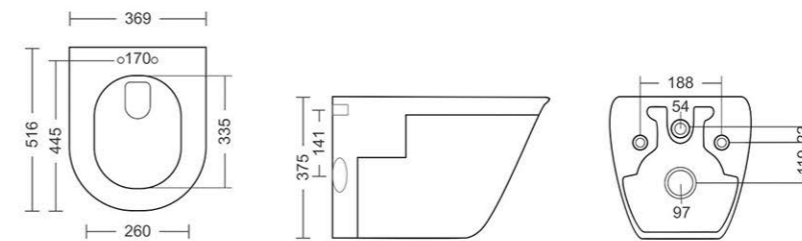

## APOLLO

WALL HUNG CLOSET  
WASH DOWN FLUSHING

L516, W369, H375MM



## CAMRI

WALL HUNG CLOSET  
WASH DOWN FLUSHING

L525, W370, H357MM

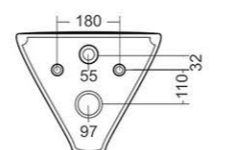
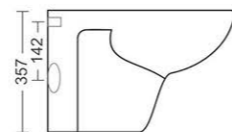
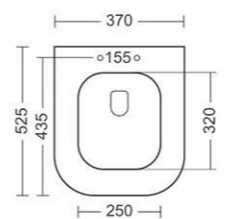

Keep smooth and  
splendor





Modern way of living



7 RIMLESS

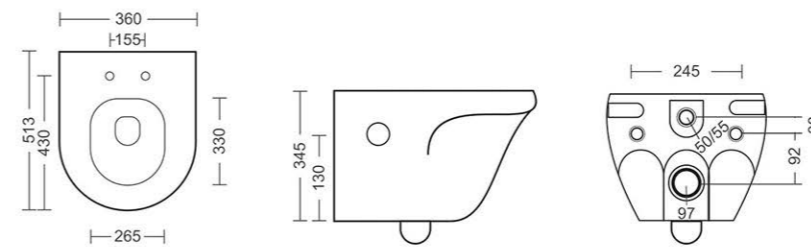

**DELTA**  
WALL HUNG CLOSET  
RIMLESS  
L513, W360, H345MM



Taste of  
elegant art

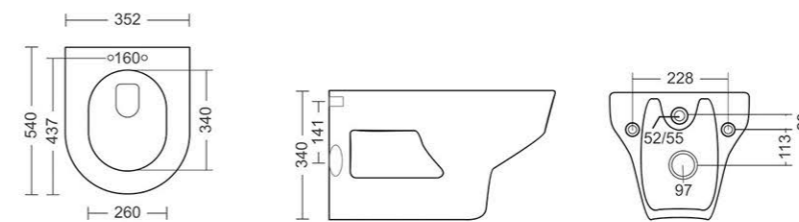

**ELLIPS**  
WALL HUNG CLOSET  
WASH DOWN FLUSHING  
L540, W352, H340MM



## JAZZY

WALL HUNG CLOSET  
WASH DOWN FLUSHING  
(WITH JET / WITHOUT JET)

L467, W363, H385MM

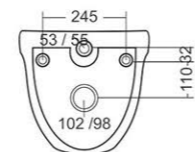
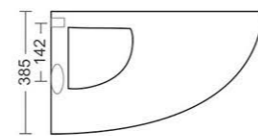
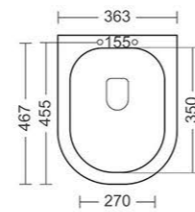

—  
—  
Adds modern  
touch





Embrace simple  
beauty

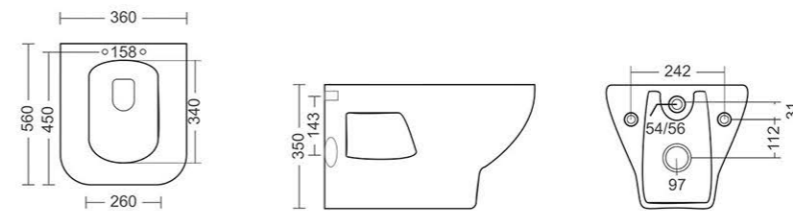

**KALLIS**  
WALL HUNG CLOSET  
WASH DOWN FLUSHING  
L560, W360, H350MM





## LUMINIA

WALL HUNG CLOSET  
WASH DOWN FLUSHING

L480, W345, H326MM

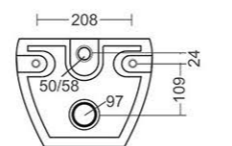
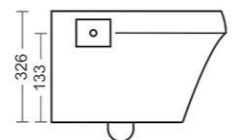
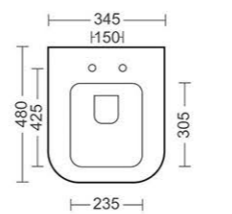

---

The charisma of  
simplicity





Reflection of your  
personality

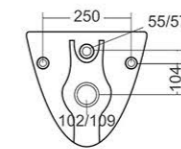
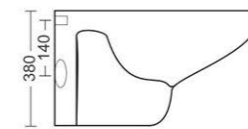
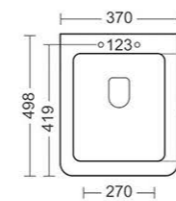

## MINI-NEPTA

WALL HUNG CLOSET  
WASH DOWN FLUSHING

L498, W370, H380MM



## NEPTA

WALL HUNG CLOSET  
WASH DOWN FLUSHING

L545, W350, H375MM

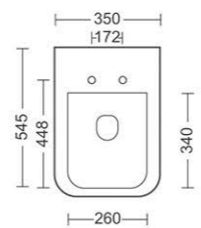
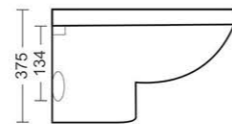
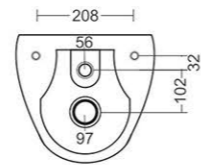

The ideal elegant  
elements





Symbol of  
elegance



7 RIMLESS

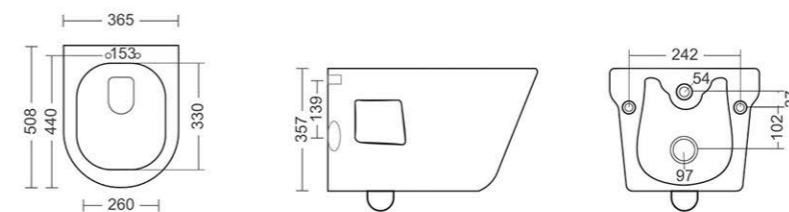

**RIGA**

WALL HUNG CLOSET  
RIMLESS

L508, W365, H357MM



## ROSSA

WALL HUNG CLOSET  
RIMLESS

L528, W355, H359MM

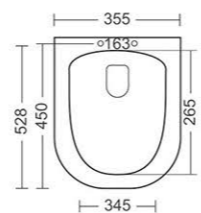
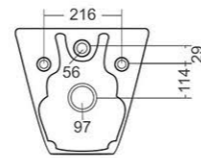

Get the absolute  
style





Reflection of  
unmatched  
brilliance

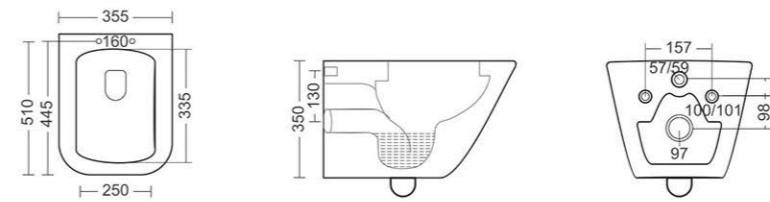

**RUBIC**  
WALL HUNG CLOSET  
WASH DOWN FLUSHING  
L510, W355, H350MM



## SNAZZY

WALL HUNG CLOSET  
WASH DOWN FLUSHING

L468, W367, H375MM

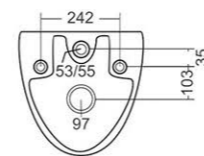
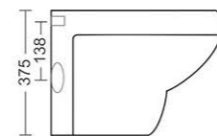
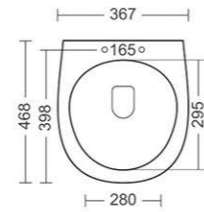

Crafted  
to perfection





Defined by  
lavish design



-  RIMLESS
-  TORNADO FLUSHING
-  4D TECHNOLOGY

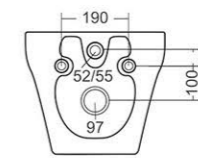
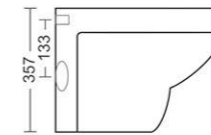
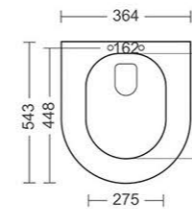

## SPENTA

WALL HUNG CLOSET  
RIMLESS  
TORNADO FLUSHING  
4D TECHNOLOGY

L543, W364, H357MM





## STAR

WALL HUNG CLOSET  
WASH DOWN FLUSHING

L498, W375, H373MM

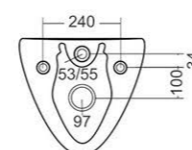
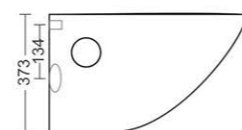
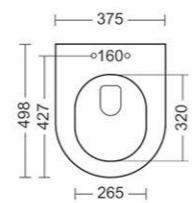

Enriches  
the bath space





Keep  
you in charm



**7** RIMLESS

**TORNADO  
FLUSHING**

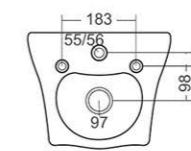
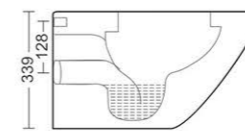
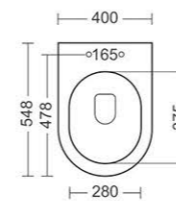

## TITA

WALL HUNG CLOSET  
RIMLESS  
TORNADO FLUSHING

L548, W400, H339MM



## VENICE

WALL HUNG CLOSET  
WASH DOWN FLUSHING

L515, W370, H357MM

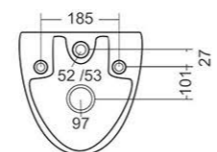
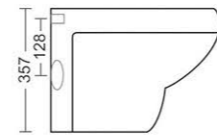
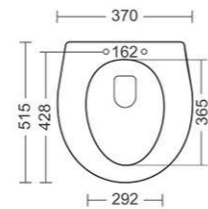

Connects  
you with arts





Bring the  
Tranquil and  
freshness

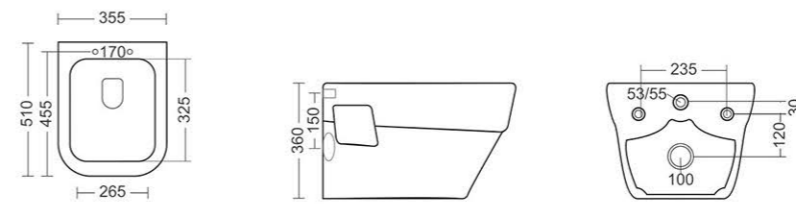

**VISTA**  
WALL HUNG CLOSET  
WASH DOWN FLUSHING  
L503, W350, H350MM



## ZETA

WALL HUNG CLOSET  
RIMLESS  
TORNADO FLUSHING

L505, W375, H335MM

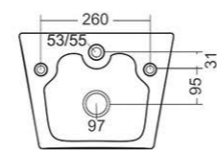
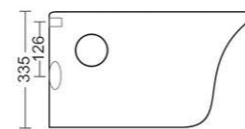
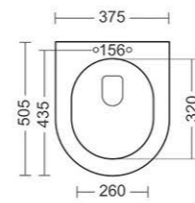

An exclusive  
and refined look





## CRETA 2 PIECE

WALL HUNG CLOSET  
WASH DOWN FLUSHING

L658, W383, H772MM

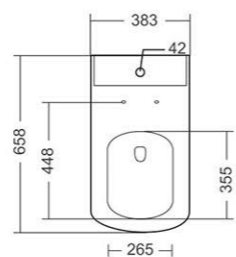
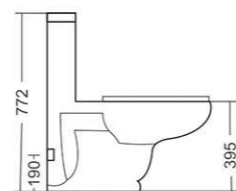

---

A natural  
finish of arts





**table top  
basin**





**ALTO**

TABLE TOP BASIN  
5MM THINNEST

L277, W277, H116MM



→ | ← 5MM  
THINNEST

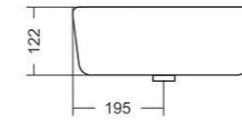
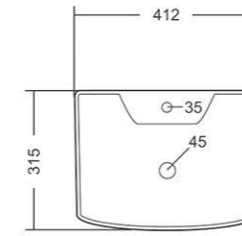
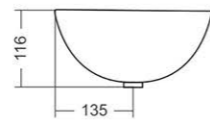
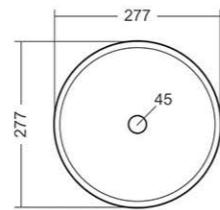

**AMY**

TABLE TOP BASIN  
5MM THINNEST

L315, W412, H122MM

→ | ← 5MM  
THINNEST







**ARIZON**

TABLE TOP BASIN  
L302, W523, H129MM

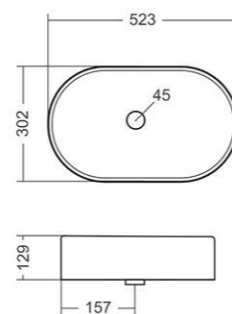

**ARTIZ**

TABLE TOP BASIN  
5MM THINNEST  
L435, W719, H129MM



→ ← 5MM THINNEST

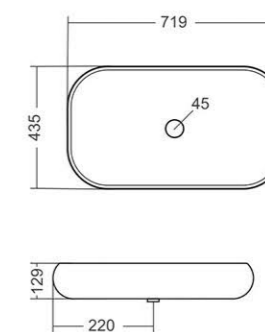



**CADIZ**

TABLE TOP BASIN  
L343, W430, H179MM

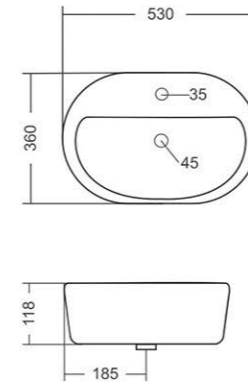

**COCO**

TABLE TOP BASIN  
5MM THINNESS

L360, W530, H118MM

→ 5MM THINNESS ←

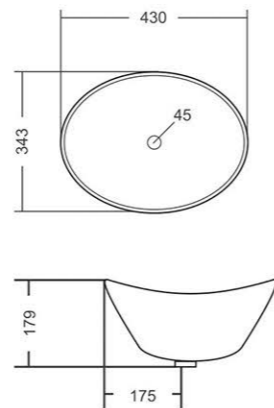



**COMPACT**

TABLE TOP BASIN  
5MM THINNEST

L398, W398, H140MM



→ 5MM THINNEST ←

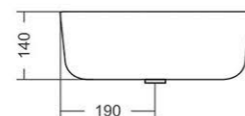
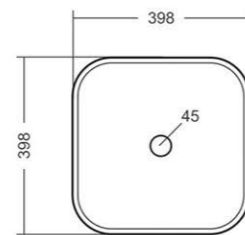

**CONCA**

TABLE TOP BASIN  
L506, W410, H160MM

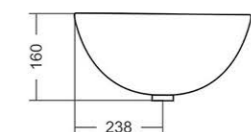
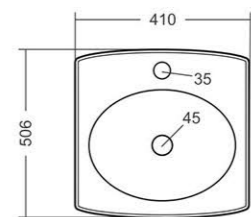

# CORAL

TABLE TOP BASIN  
5MM THINNEST

L432, W432, H129MM



5MM  
THINNEST

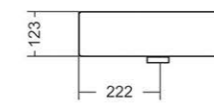
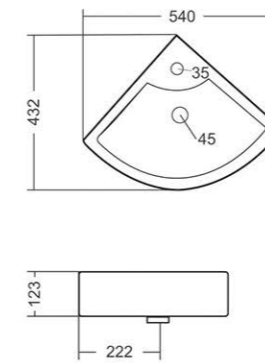
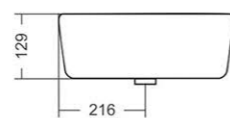
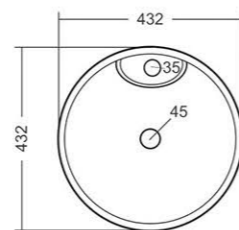

# CORUS

TABLE TOP BASIN  
L432, W540, H123MM





## CROMA

TABLE TOP BASIN  
L446, W160, H400MM

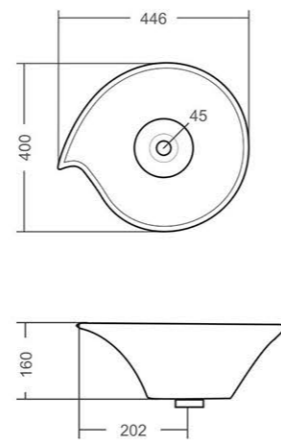

## CRUSE

TABLE TOP BASIN  
L377, W688, H147MM

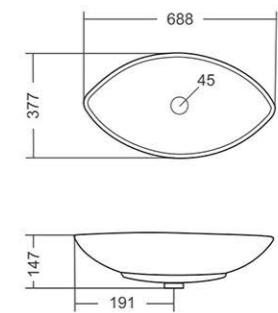

# CRYSTAL

TABLE TOP BASIN  
5MM THINNEST

L407, W505, H145MM



→ ← 5MM  
THINNEST

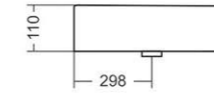
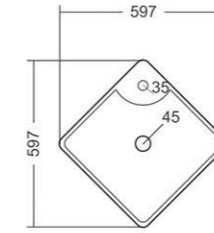
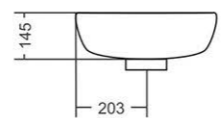
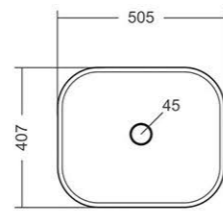

# CUBE

TABLE TOP BASIN  
5MM THINNEST

L597, W597, H110MM

→ ← 5MM  
THINNEST





### ERA

TABLE TOP BASIN  
L427, W427, H173MM

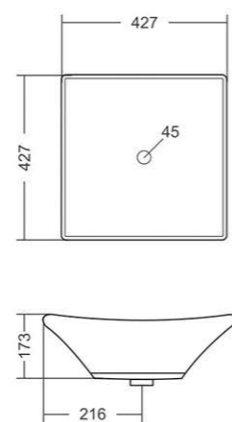

### FLORA

TABLE TOP BASIN  
5MM THINNEST  
L375, W662, H145MM



→ ← 5MM THINNEST

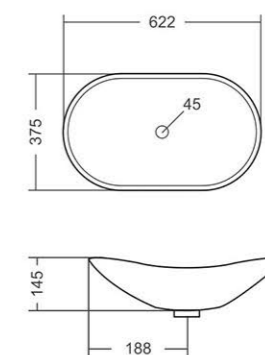



**GEO**

TABLE TOP BASIN  
L360, W368, H151MM

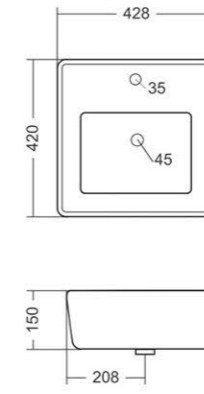
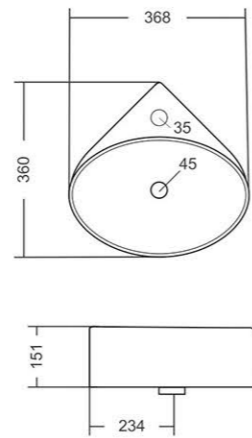

**INOX**

TABLE TOP BASIN  
L420, W428, H150MM







## IRIS

TABLE TOP BASIN  
5MM THINNEST

L458, W458, H176MM



→ 5MM THINNEST ←

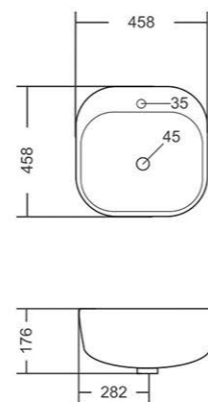

## ISVEA

TABLE TOP BASIN  
5MM THINNEST

L375, W468, H132MM



→ 5MM THINNEST ←

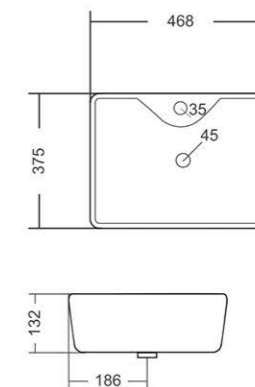



**LEO**

TABLE TOP BASIN  
5MM THINNEST

L383, W544, H165MM



5MM  
THINNEST

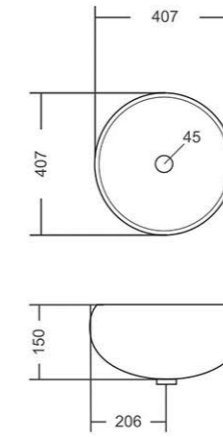
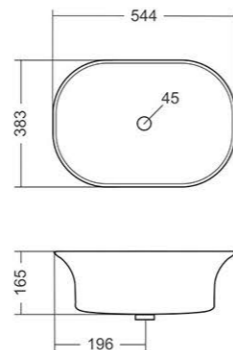

**LEWIS**

TABLE TOP BASIN  
L407, W407, H150MM





## LINIA

TABLE TOP BASIN  
5MM THINNEST

L395, W580, H142MM



→ 5MM THINNEST ←

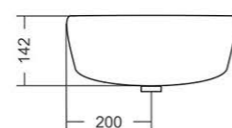
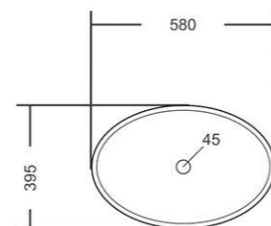

## MARCO

TABLE TOP BASIN  
5MM THINNEST

L405, W405, H115MM



→ 5MM THINNEST ←

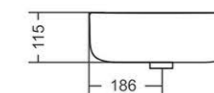
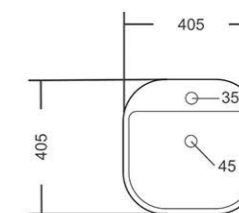



**METRO**

TABLE TOP BASIN  
5MM THINNEST

L540, W380, H126MM



→ 5MM  
THINNEST ←

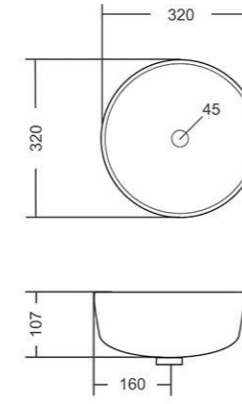
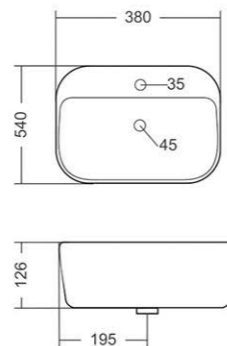

**NEXA**

TABLE TOP BASIN  
5MM THINNEST

L320, W320, H107MM

→ 5MM  
THINNEST ←





**NEXUS**

TABLE TOP BASIN  
L360, W470, H124MM

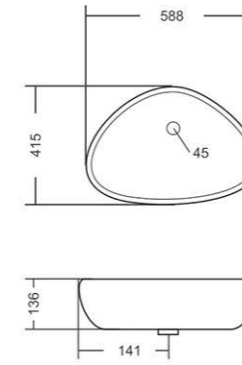
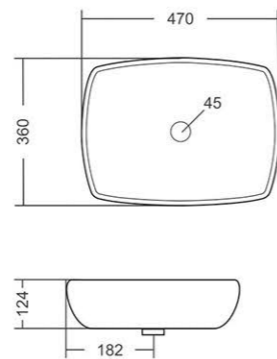

**PRIMA**

TABLE TOP BASIN  
5MM THINNEST

L415, W588, H136MM

→ ← 5MM THINNEST





**PRISTINE**

TABLE TOP BASIN  
L413, W570, H125MM

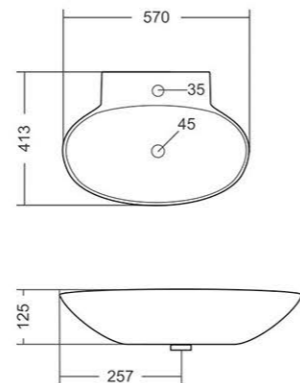

**RADO**

TABLE TOP BASIN  
L437, W432, H116MM

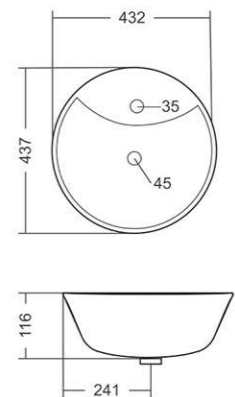



**RIPON**

TABLE TOP BASIN  
L391, W527, H125MM

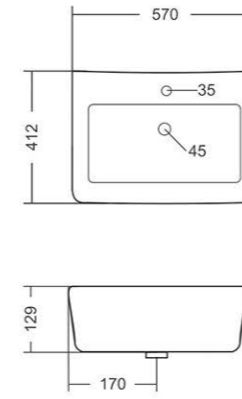

**SAI**

TABLE TOP BASIN  
L412, W570, H129MM

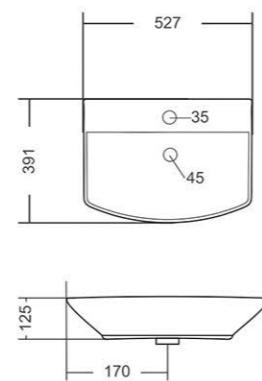



## SLIK

TABLE TOP BASIN  
L373, W373, H138MM

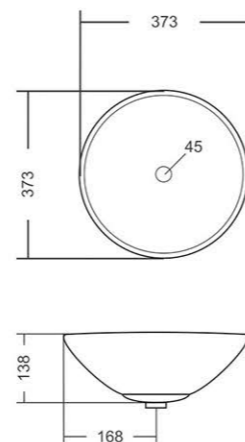

## SLOG

TABLE TOP BASIN  
L410, W410, H126MM

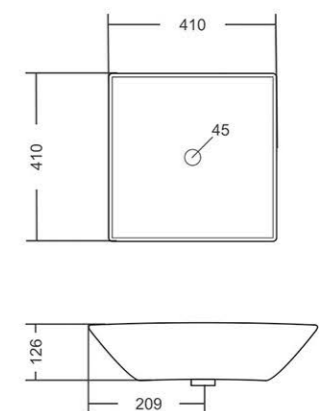





**SOAR**

TABLE TOP BASIN  
L355, W456, H136MM

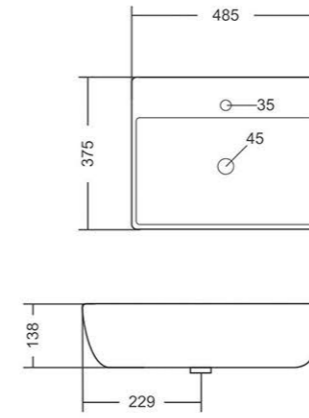

**SOBER**

TABLE TOP BASIN  
L375, W485, H138MM

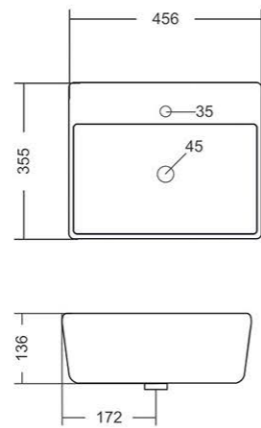



## STAR

TABLE TOP BASIN  
L375, W375, H121MM



## SUN

TABLE TOP BASIN  
L395, W395, H157MM

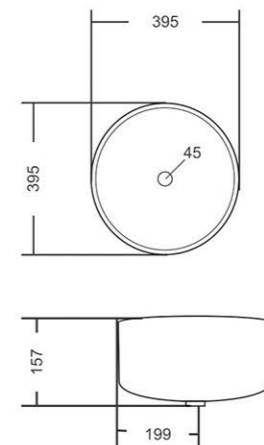
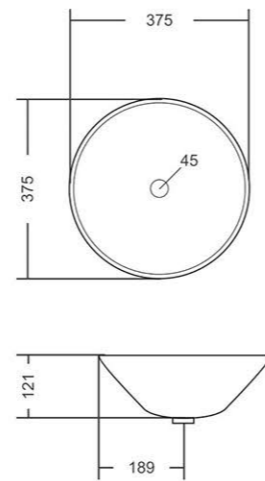



**SYMON**

TABLE TOP BASIN  
L420, W413, H127MM

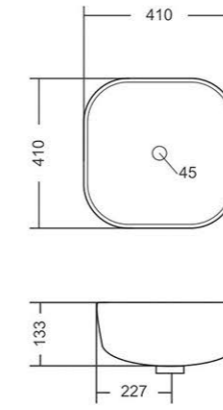
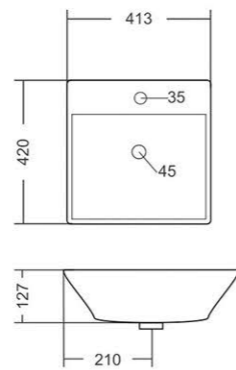

**TERRA**

TABLE TOP BASIN  
L410, W410, H133MM





## VIVA

TABLE TOP BASIN  
5MM THINNEST

L435, W435, H137MM



→ ← 5MM  
THINNEST

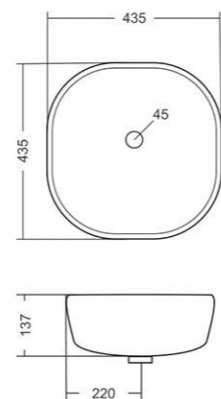

## XOLO

TABLE TOP BASIN  
5MM THINNEST

L300, W300, H130MM



→ ← 5MM  
THINNEST

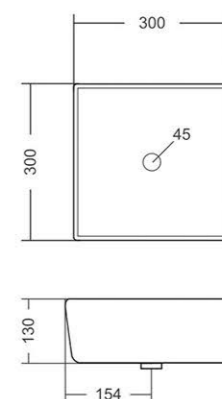



# wash basin



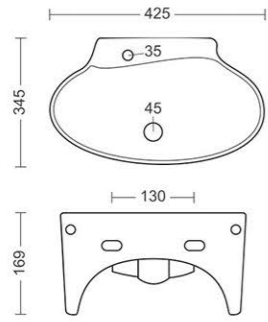

**APPLE**

WASH BASIN  
L345, W425, H169MM



**CANVAS**

WASH BASIN  
L350, W457, H153MM

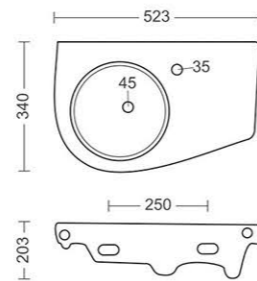

**BRUNO**

WASH BASIN  
L340, W525, H203MM

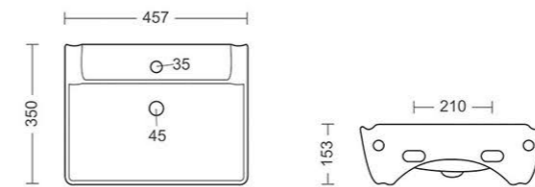

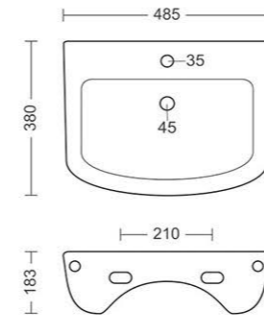

## CHICAGO

WASH BASIN  
L380, W485, H183MM



## CLASSIC

WASH BASIN  
L360, W460, H200MM

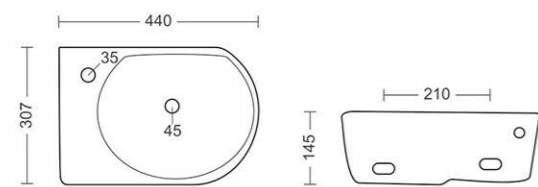
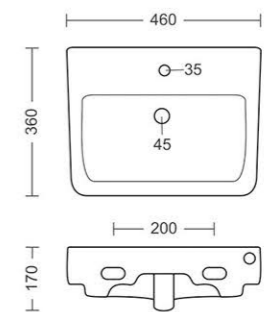

## CASSIO

WASH BASIN  
L307, W440, H145MM

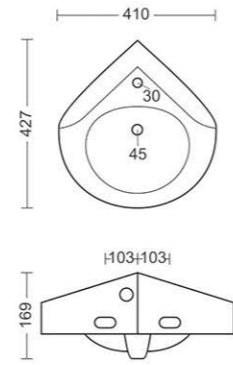

**CORNER**

WASH BASIN  
L427, W410, H169MM

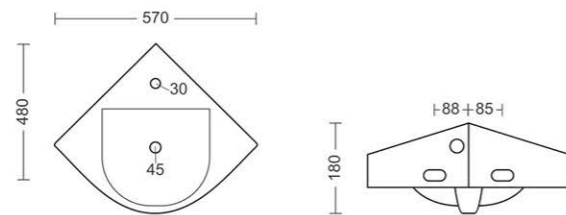

**COZY**

WASH BASIN  
L480, W570, H180MM

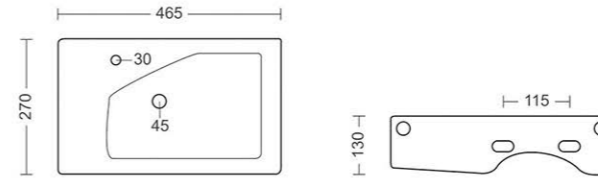

**ESTILO**

WASH BASIN  
L270, W465, H130MM





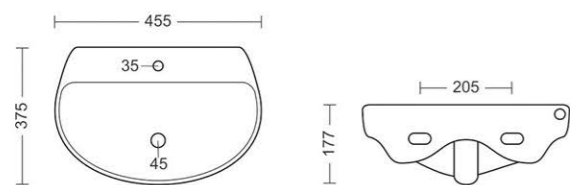

**Eva**  
WASH BASIN  
L375, W455, H177MM

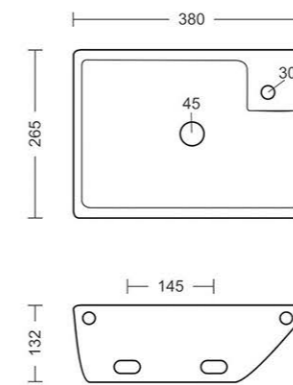

**FIERO**  
WASH BASIN  
L265, W380, H132MM

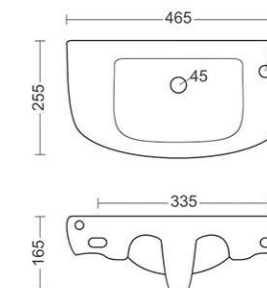

**FLAIRE**  
WASH BASIN  
L265, W465, H165MM

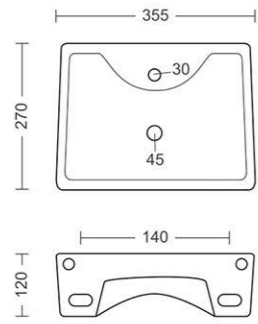

**GEM**

WASH BASIN  
L270, W355, H120MM

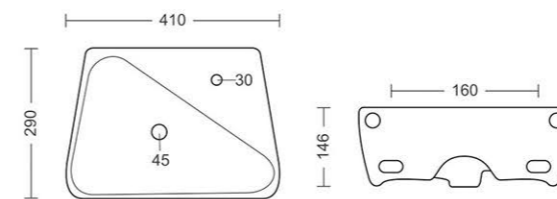

**LILY**

WASH BASIN  
L290, W410, H146MM

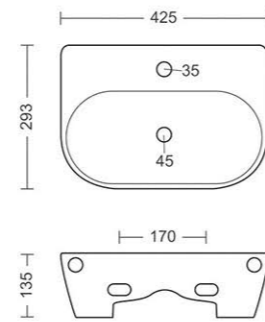

**LEXO**

WASH BASIN  
L293, W425, H135MM

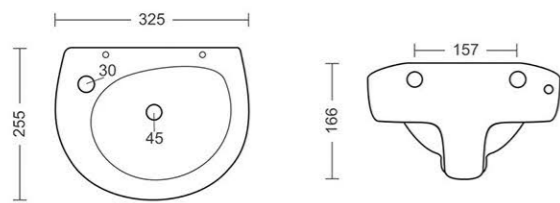

**MANGO**  
WASH BASIN  
L255, W325, H166MM

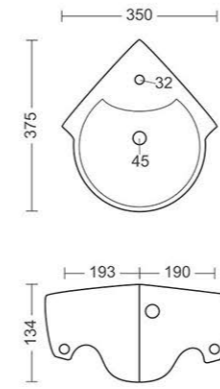

**MINI CORNER**

WASH BASIN  
L375, W350, H134MM



**MINI SYNDICATE**

WASH BASIN  
L325, W285, H130MM

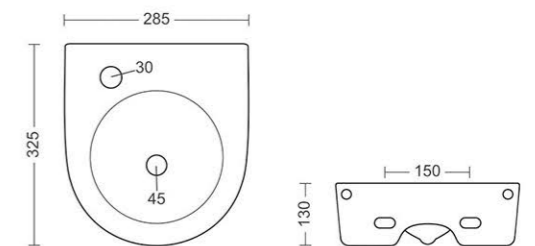

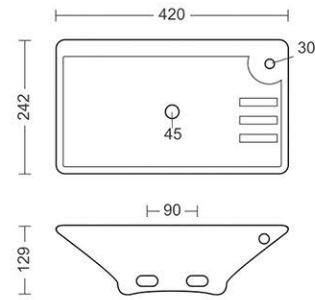

**PARITY**

WASH BASIN  
L242, W420, H129MM

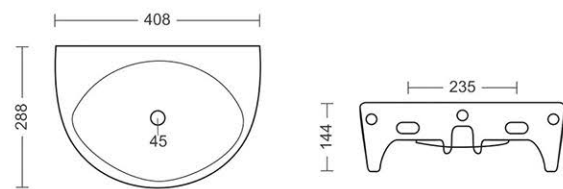

**PEARL**

WASH BASIN  
L288, W408, H144MM

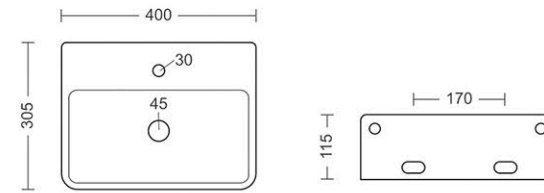

**PLAZMA**

WASH BASIN  
L305, W400, H170MM



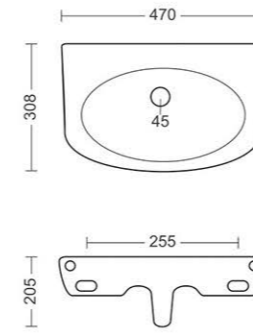

**SIPRA**

WASH BASIN  
L308, W470, H205MM

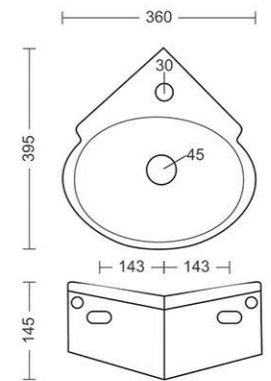

**SKIM**

WASH BASIN  
L395, W360, H145MM

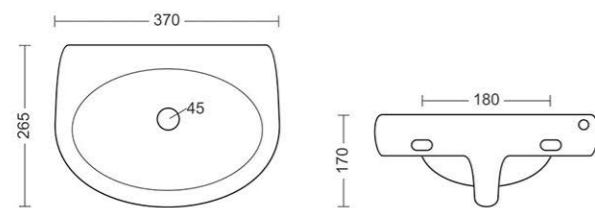

**SHALLY**

WASH BASIN  
L265, W370, H170MM

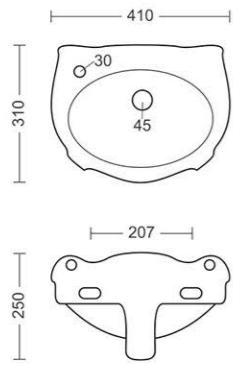

**SMILE**

WASH BASIN  
L310, W410, H250MM

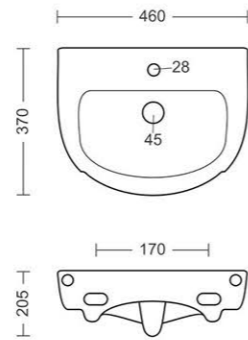

**SPOUSE**

WASH BASIN  
L370, W460, H170MM

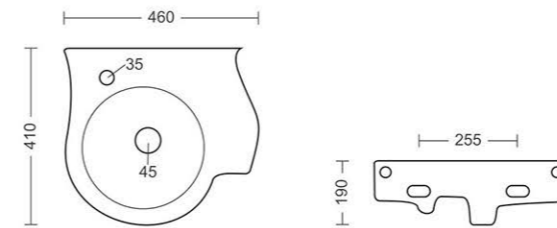

**STYLO**

WASH BASIN  
L410, W460, H190MM

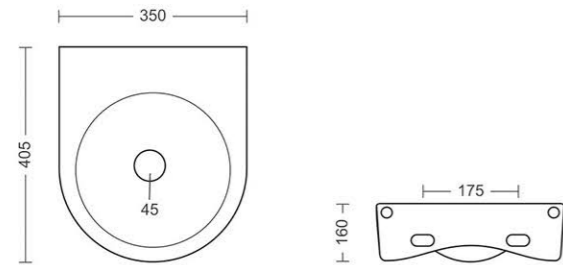

**SYNDICATE**

WASH BASIN  
L405, W350, H160MM

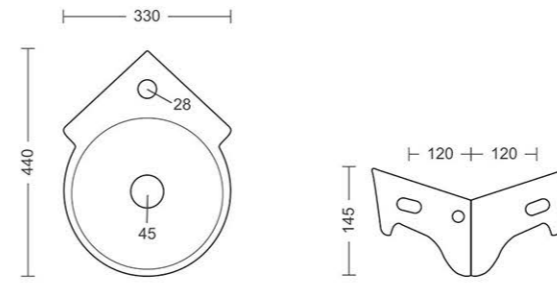

**TIM**

WASH BASIN  
L440, W330, H145MM





# one piece basin







**ADOR**

ONE PIECE BASIN  
L440, W500, H365MM

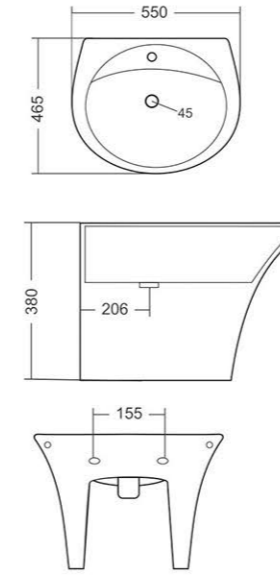
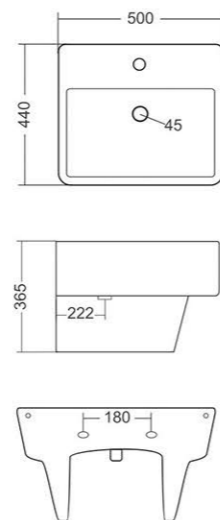

**ALFA**

ONE PIECE BASIN  
L465, W550, H380MM





**BIG PETAL**

ONE PIECE BASIN  
L440, W460, H327MM

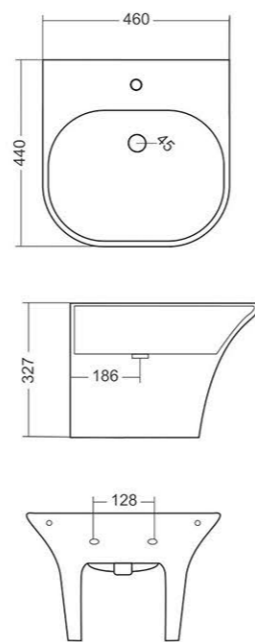

**OMEGA**

ONE PIECE BASIN  
L370, W370, H225MM

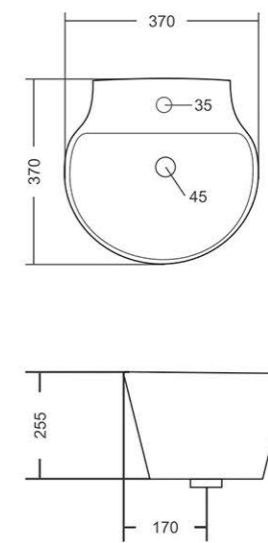



**PETAL**

ONE PIECE BASIN  
L370, W340, H280MM

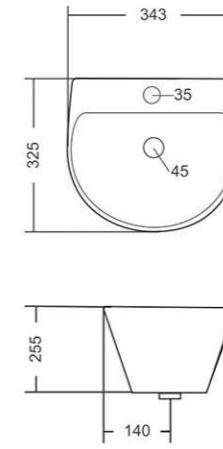

**POLO**

ONE PIECE BASIN  
L325, W343, H255MM

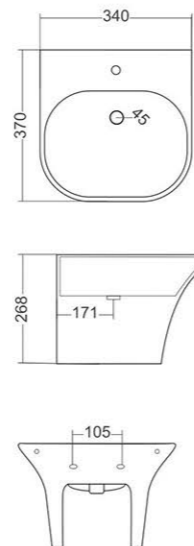



### SYSCO

ONE PIECE BASIN  
L445, W435, H340MM

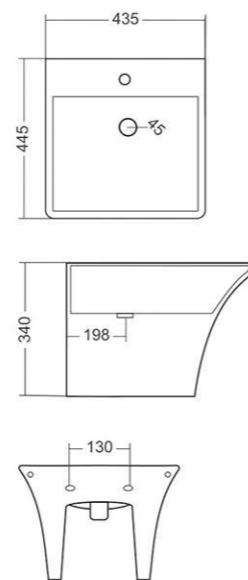

## PREMIUM SANITARYWARE



WATER SLIDES FAST  
ON THE SURFACE

### THE PRODUCT ATTRIBUTES



Water-repellent: water slides fast on the surface



The surface is perfectly smooth



Easy and quick cleaning



Greater surface brilliance



Environmental Sustainability  
reduced water consumption and cleaning detergents



High resistance to external agents,  
longer durability.

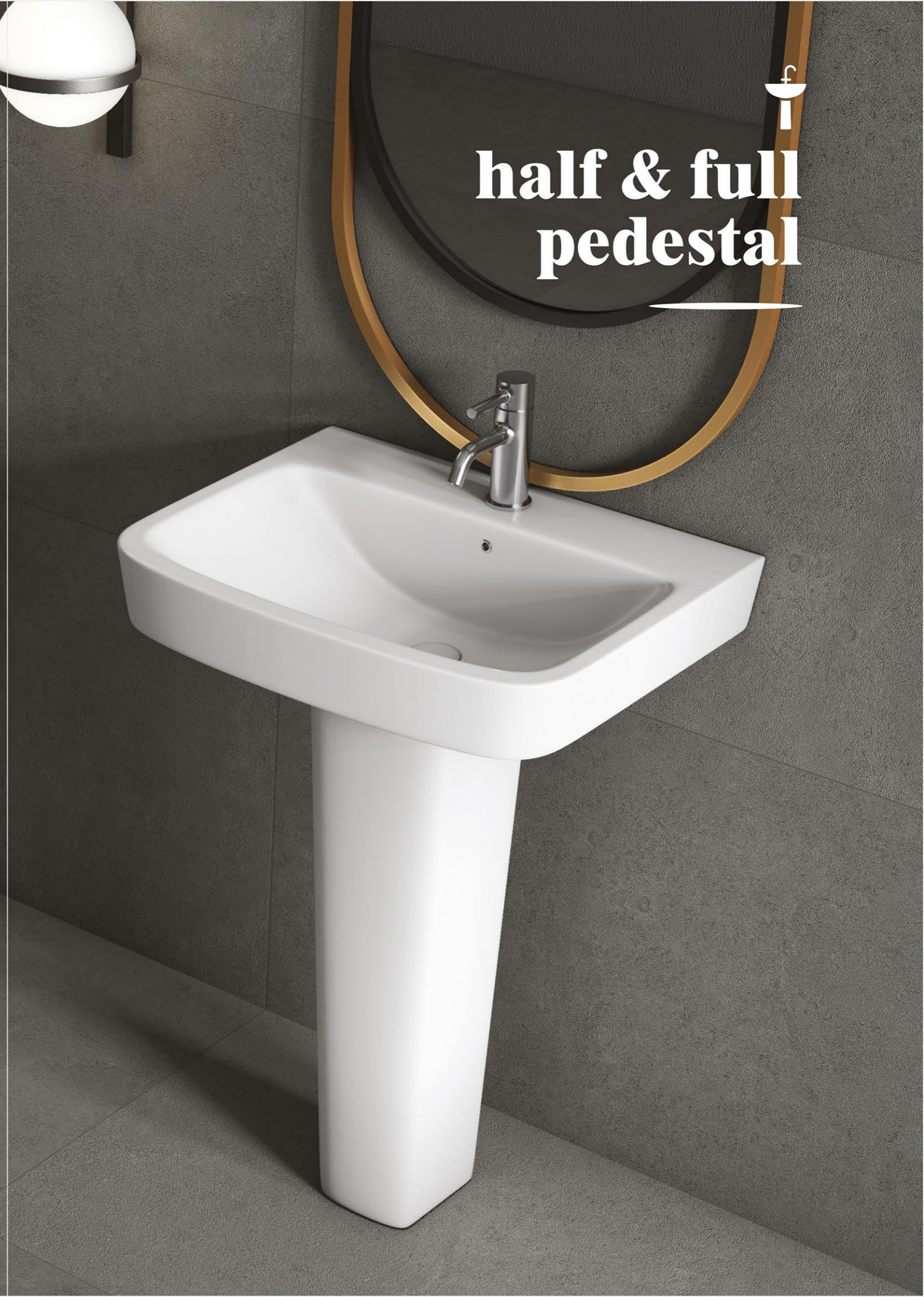

**half & full  
pedestal**



FULL PEDESTAL  
L460, W570, H850MM

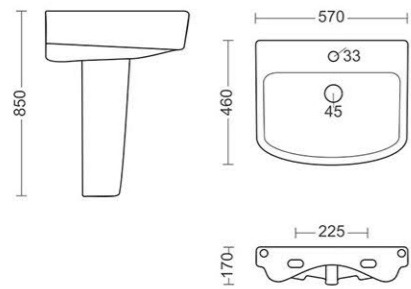

## ALTIS

HALF PEDESTAL  
L460, W568, H516MM

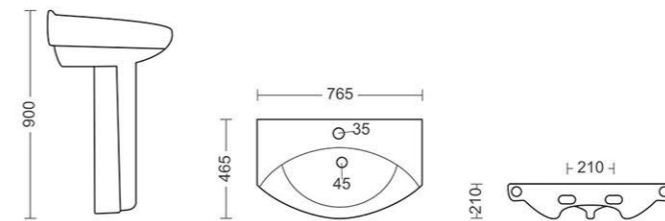
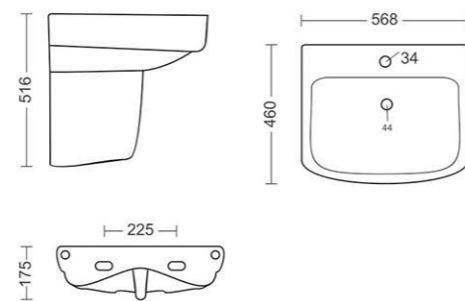

## CORINA

FULL PEDESTAL  
L465, W765, H900MM

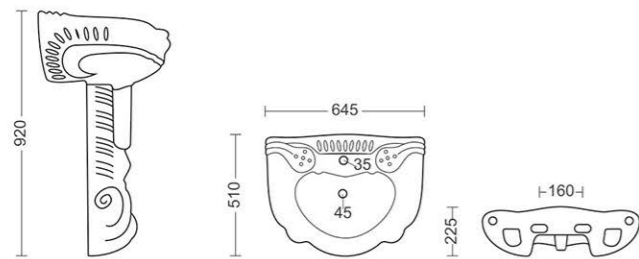

**MAJESTY**

FULL PEDESTAL  
L510, W645, H920MM

FULL PEDESTAL  
L420, W530, H870MM

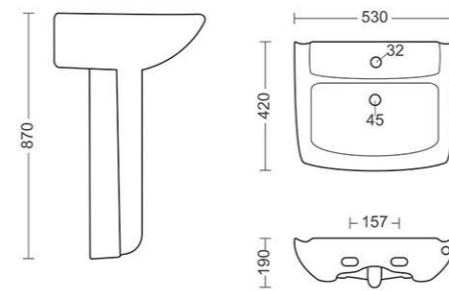

**LOURET**

HALF PEDESTAL  
L425, W520, H505MM

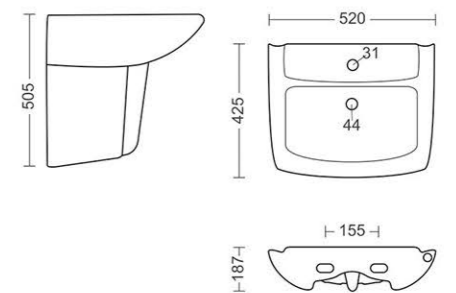

FULL PEDESTAL  
L422, W560, H850MM

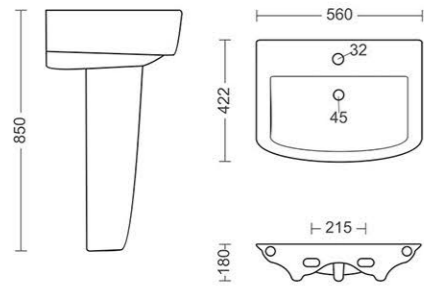

## NEO

HALF PEDESTAL  
L430, W555, H505MM

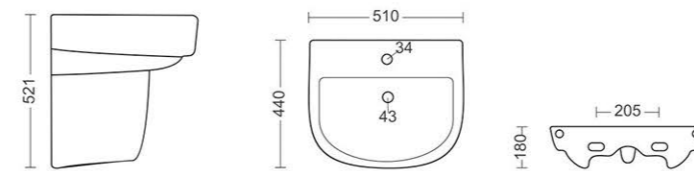
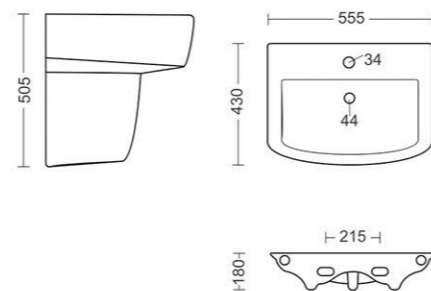

**NOVA**  
HALF PEDESTAL  
L440, W510, H521MM



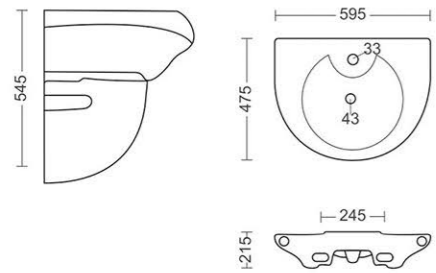

HALF PEDESTAL  
L475, W595, H545MM

## OLIVE

FULL PEDESTAL  
L475, W595, H880MM

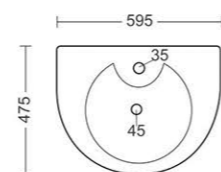
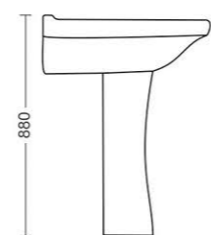

FULL PEDESTAL  
L465, W585, H875MM

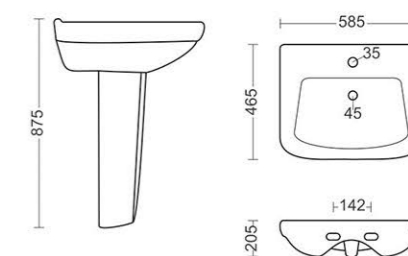

## PARISH

HALF PEDESTAL  
L360, W650, H720MM

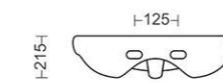
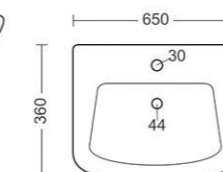
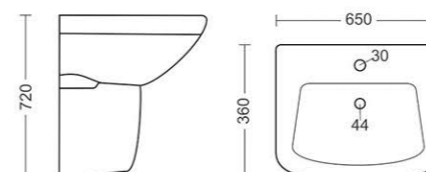

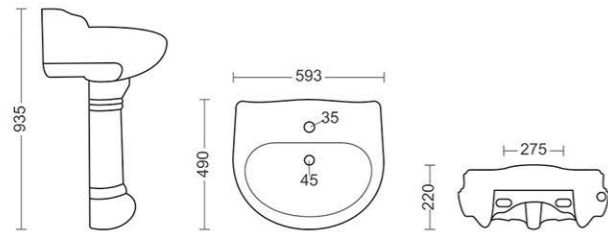

**SERENA**

FULL PEDESTAL  
L490, W593, H935MM

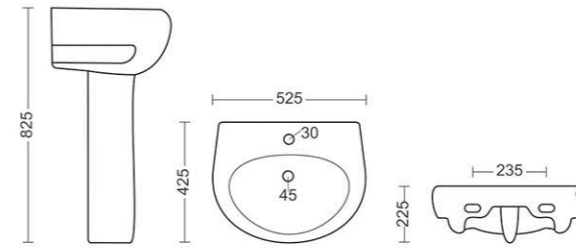

**SAMITE**

FULL PEDESTAL  
L425, W525, H825MM



FULL PEDESTAL  
L435, W570, H880MM

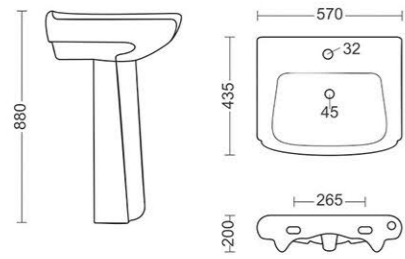

## SOPHIA

HALF PEDESTAL  
L425, W560, H513MM

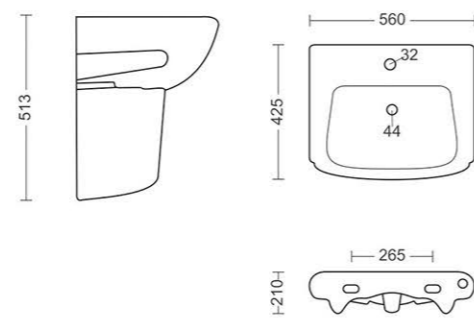

## STEPHY

FULL PEDESTAL  
L430, W590, H815MM

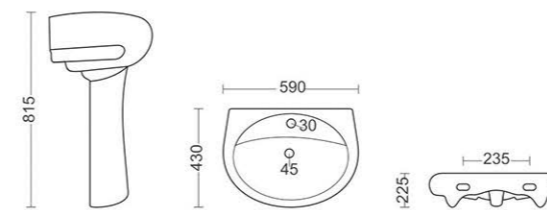

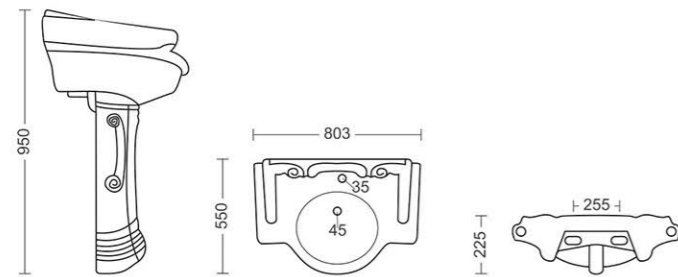

## STERLING ROYA

FULL PEDESTAL  
L550, W803, H950MM

## STERLING

FULL PEDESTAL  
L510, W645, H970MM



## SCOOTY

HALF PEDESTAL  
L365, W480, H510MM

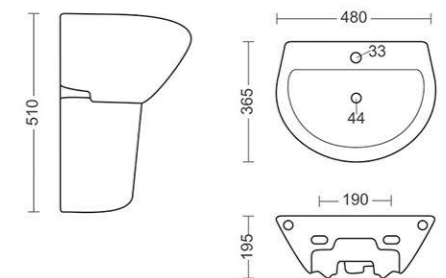

FULL PEDESTAL  
L455, W580, H845MM

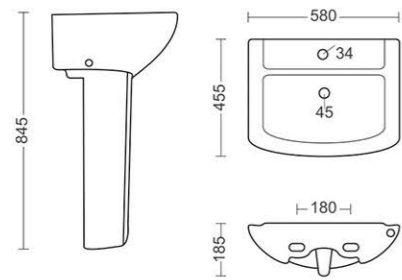

## VENICE

HALF PEDESTAL  
L455, W580, H545MM

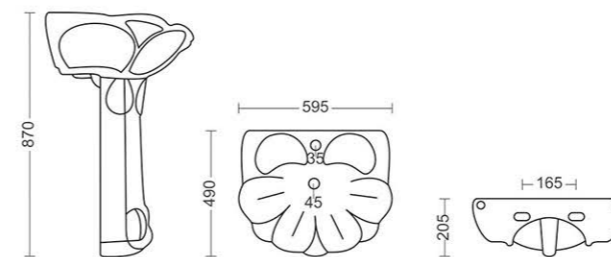
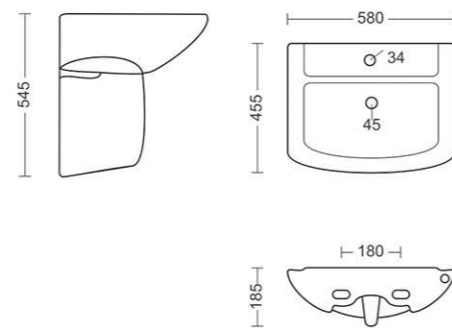

## SUPREME

FULL PEDESTAL  
L490, W595, H870MM

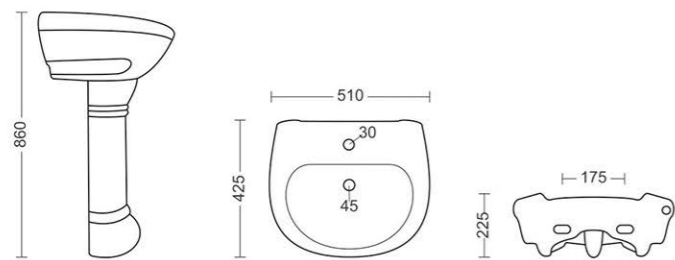

**SWING**  
FULL PEDESTAL  
L425, W510, H860MM

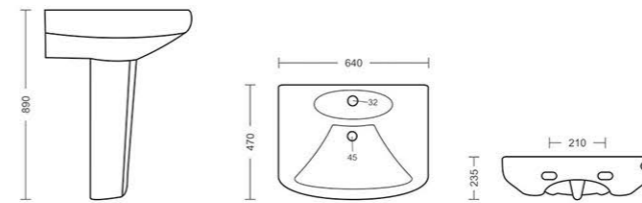

**VEGA**  
FULL PEDESTAL  
L470, W640, H890MM



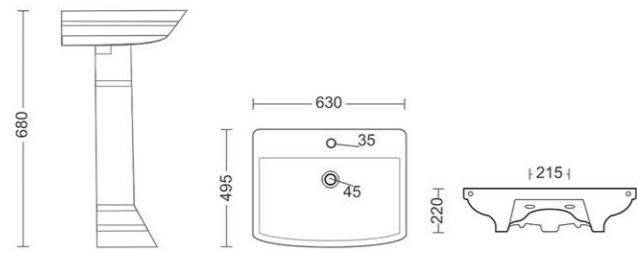

**LARA**  
 FULL PEDESTAL  
 L620, W490, H800MM

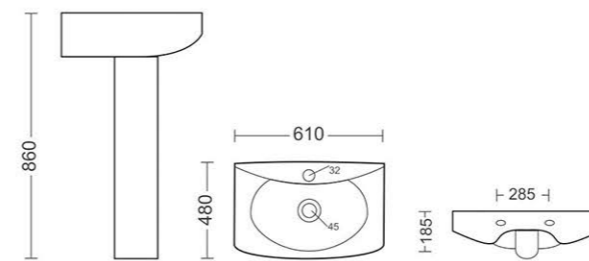

**RETRO**  
 FULL PEDESTAL  
 L610, W475, H863MM



# under counter basin

---





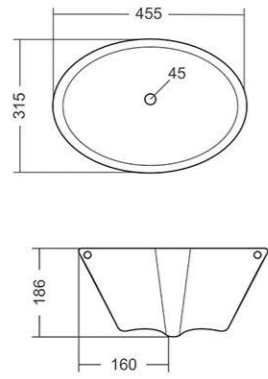

**ASTA**

UNDER COUNTER BASIN  
L315, W455, H186MM

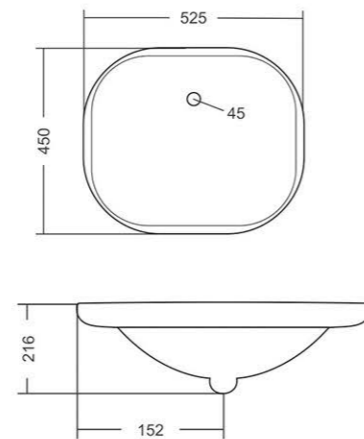

**GARNET**

UNDER COUNTER BASIN  
L450, W525, H216MM

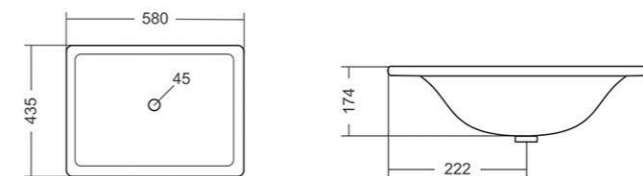

**LATINA**

UNDER COUNTER BASIN  
L435, W580, H174MM

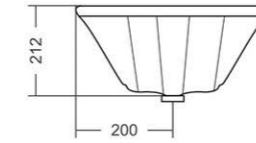
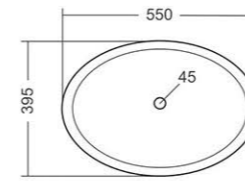

**SPINZ**

UNDER COUNTER BASIN  
L395, W550, H212MM

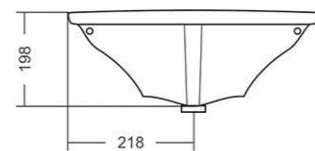
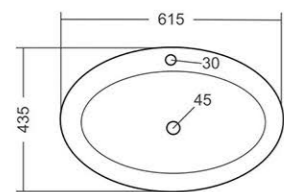

**LOMANI**

UNDER COUNTER BASIN  
L435, W615, H198MM



# floor mount Ewc

water closet  
& orrisa pan





## GRACE

FLOOR MOUNT EWC  
WASH DOWN

L545, W350, H410MM

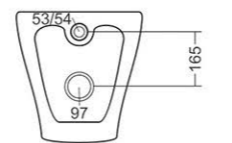
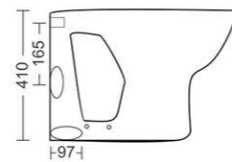
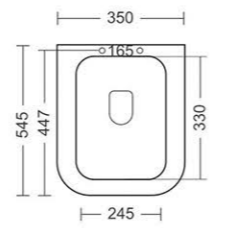

Experience the  
modern craft





## SOFEN

FLOOR MOUNT EWC  
WASH DOWN

L530, W350, H397MM

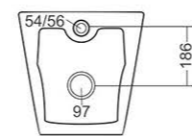
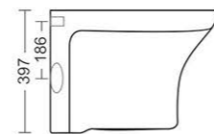
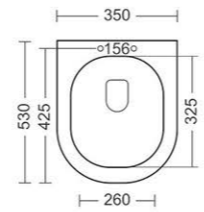

Blending into  
elegant style





Turn into  
gorgeous looks

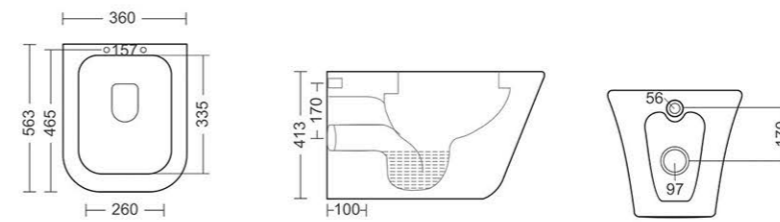

## RECTO

FLOOR MOUNT EWC  
WASH DOWN

L563, W360, H413MM



## DIAMOND

FLOOR MOUNT EWC  
WASH DOWN

L565, W350, H420MM

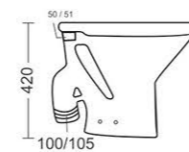
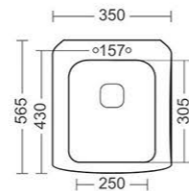

Reflecting the  
modern lifestyle



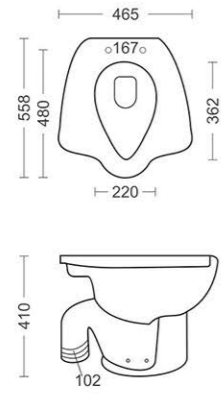

## ANGLO

WATER CLOSET  
L558, W465, H410MM



## SELVO

WATER CLOSET  
L545, W465, H405MM

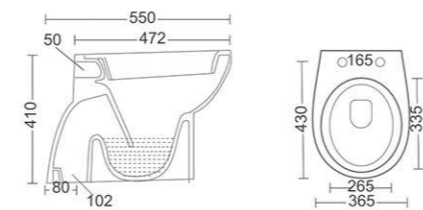

## SPICE

WATER CLOSET  
L430, W550, H410MM



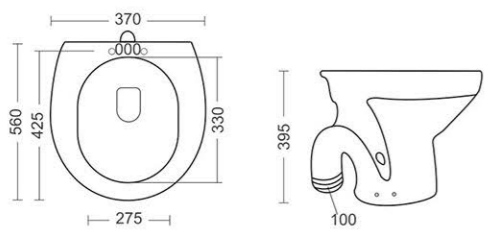

### STEPHY

WATER CLOSET  
L560, W370, H395MM

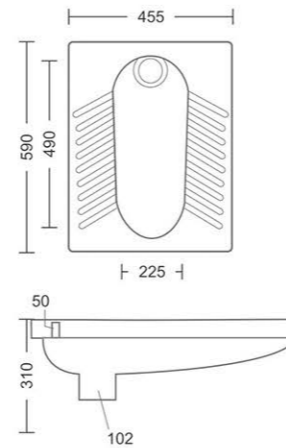

### 23'' ORISSA

ORRISA PAN  
L590, W455, H310MM



### AQU PAN

ORRISA PAN  
L580, W445, H290MM

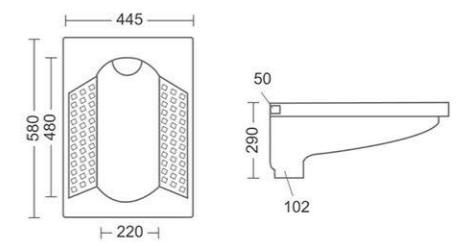

## ARAB PAN (CT PAN)

ORRISA PAN  
L535, W452, H185MM

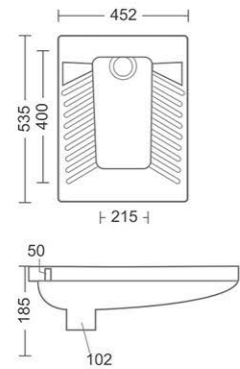

## HEALTH ORISSA

ORRISA PAN  
L590, W455, H310MM

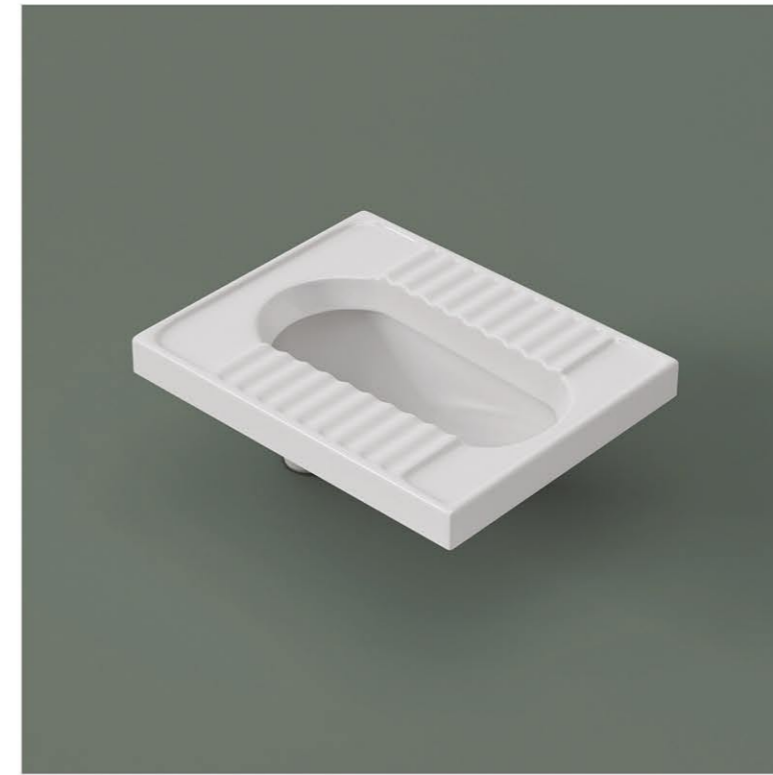
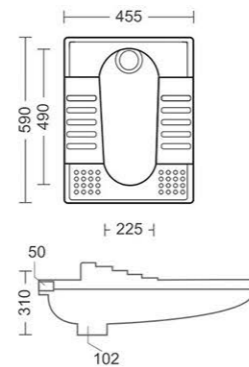

## O.P. 20"

ORRISA PAN  
L515, W410, H180MM

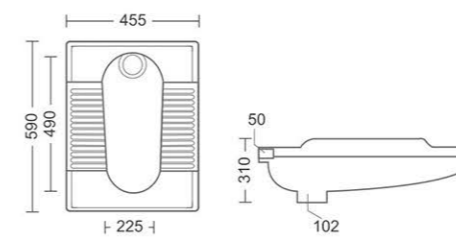
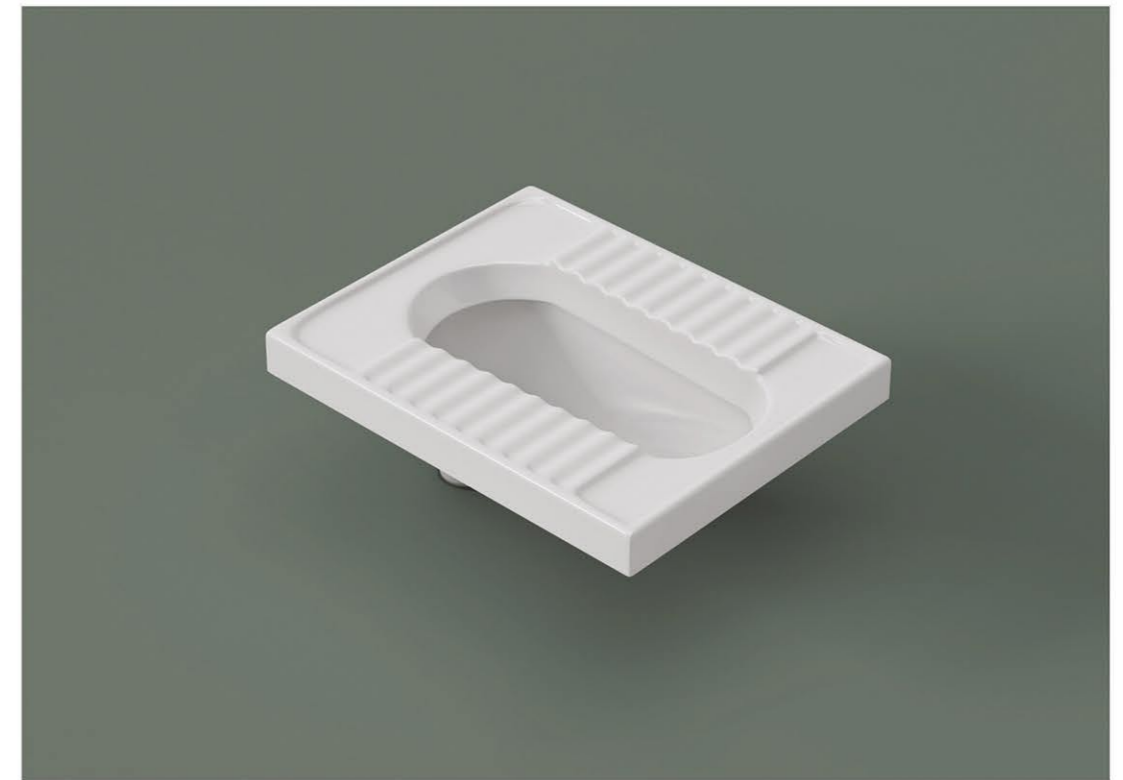
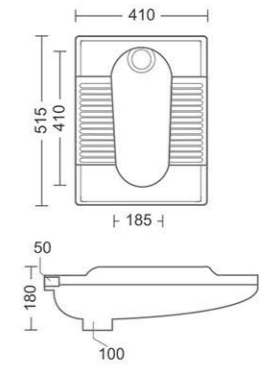

## O.P. 23"

ORRISA PAN  
L590, W455, H310MM

  
**urinal**



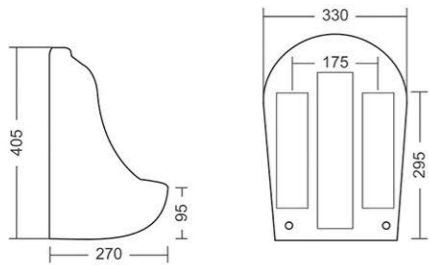

**ALDO**  
URINAL  
L270, W330, H405MM

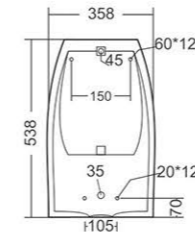
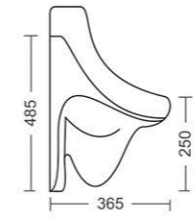

**BRONZA**  
URINAL  
L365, W358, H538MM



**DIVISIONAL PLATE**

URINAL  
L95, W327, H675MM

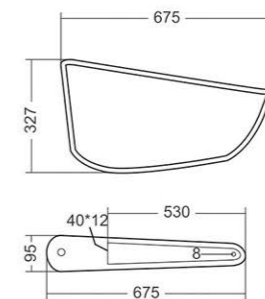

# EUREKA

ORRISA PAN  
L250, W300, H450MM

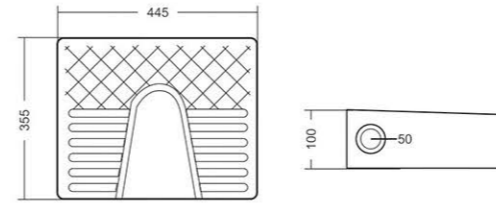
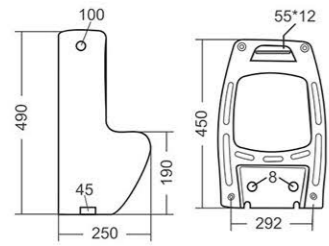

# LADIES URINAL

URINAL  
L355, W445, H100MM



# KITO

ORRISA PAN  
L320, W240, H500MM

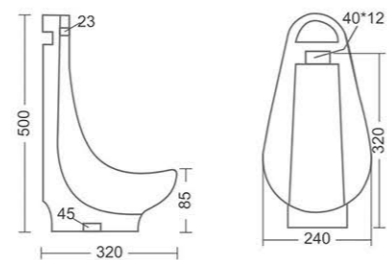

# LARGE

URINAL  
L375, W400, H595MM

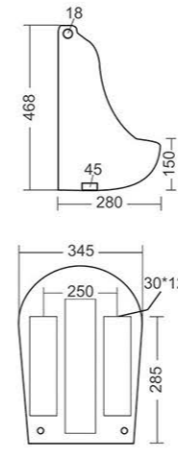
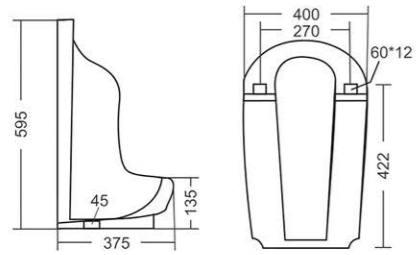

# TOVA

URINAL  
L280, W345, H468MM



# SPARK

URINAL  
L310, W320, H515MM

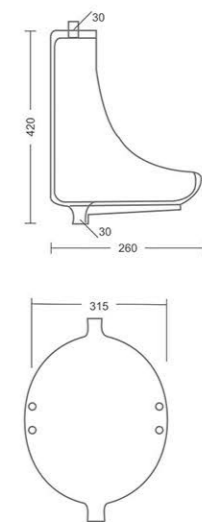
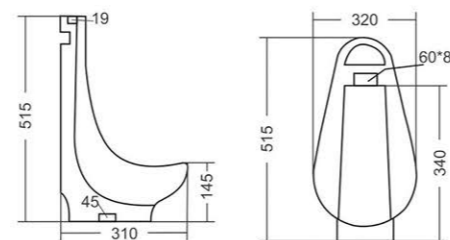

# FLAT BACK

URINAL  
L260, W315, H420MM

## INSTALLATION

### MAINTENANCE

A few minutes everyday... and a beautiful bathroom forever. Like any other part of your house, the bathroom can be made to look great and made to last if it is taken care of regularly. Here are some simple tips that can help you keep your bathroom space and span.

#### Wash Basin

The wash basin needs to be washed with a mild detergent at least once a day. After washing, the basin must be wiped dry to avoid water stains, especially on dark colours.

#### Closets

Use a plastic bristled brush with a plastic handle to scrub the toilet with a cleanser like Harpic, at least once a day.

After flushing the toilet, give it a "once over" with the brush to avoid minute discoloring.

Keep the toilet brush handy in a convenient stand/ cover nearby.

In the case of Vitreous China Sanitaryware like Silware toilets and basins, if there has been no maintenance over a long period of time, water deposits and discoloration can form on the surface of areas that get wet. In such cases, these stains/ marks can be removed with the help of a solution of dilute hydrochloric acid.

Clean with a soft cloth and warm soapy water.

Use a liquid cleaner at least once a week. Do not use powder paste, thinner or dry cleaning liquids.

To remove fine scratches, use Brasso or car rubbing compound and then polish with a polish cloth.

### CONCEALED WALL HUNG

1. If the wall is going to be plastered for a thickness of 12 mm and a tile thickness of 6-7 mm, the projection of the bolts from the finished wall should be 66 mm only.
2. If the thickness of plastering and tile is less than the dimensions mentioned above, the bolts that are supplied along with the bracket should be moved into the wall by using a suitable spacer washer between the bolt head and the bracket frame.
3. The bracket should be buried into the floor so that the height from the center line of the bolt to the surface of the finished floor is 320 mm.

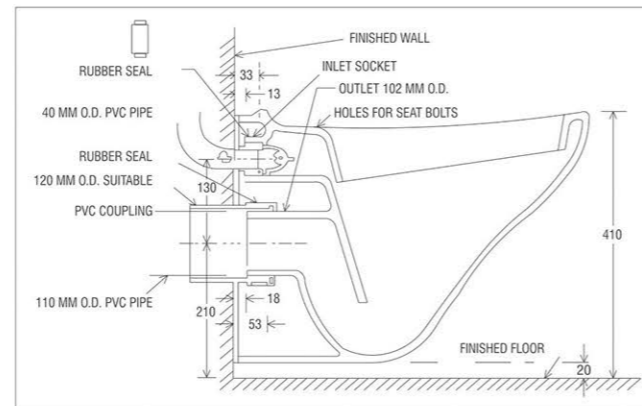

## INSTALLATION & MAINTENANCE TIPS

1. Use C.I. Brackets with rag bolts to install Wash Basin with or without pedestal. If Wash Basin is large in size than it is recommended to install on pedestal screwed to the floor.
2. All Wall Mounting E.W.C. to be installed with the help of C.I. Chair bracket as well as with heavy duty rag bolt with cap and rubber bush and outlet coupler.
3. All Floor Mounting E.W.C. to be fixed on the floor with help of Screwed and do not use Cement at the hollow portion of E.W.C.
4. It is recommended to clean regular with dry cloth / Mild Detergent to avoid stain & if required, diluted Hydrochloric acid may be used.
5. Do not use hard bristled / wire brush for cleaning to avoid scratches on wares.

## TECHNICAL SPECIFICATION

PARTICULARS	I.S.I REQUIREMENTS	OUR VALUE
WATER ABSORPTION	< 0.5%	< 0.25%
MODULUS OF RUPTURE	> 600 KG/CM2	750 KG/CM2
CRAZING RESISTANCE (STEAM PRESSURE OF 3.7 KG/CM2 FOR 4 HRS)	NO CRAZING UPTO TWO CYCLES	NO CRAZING UPTO FOUR CYCLES
MINIMUM FIRED THICKNESS	SHOULD BE 6.0 MM AT ANY AREA	> 7 MM AT ANY AREA
WARPAGE	APPLIANCE SHOULD NOT EXCEED SPECIFIED LIMIT	WELL WITHIN IN PERMISSIBLE RANGE
THICKNESS OF GLAZE AT ANY PLACE	NOT SPECIFIED	400 MICRONS (0.4 MM)
SURFACE QUALITY	NO WAVY FINISH ON VISIBLE SURFACE	NO WAVY APPEARANCE
DISCOLOURATION	NONE ON VISIBLE SURFACE	NONE
RESISTANCE TO CHEMICALS	SHOULD BE RESISTANT TO ALL HOUSE HOLD CHEMICALS	PASSES
RESISTANCE TO STAINS AND BURNS	NO STAIN SHOULD REMAIN ON TESTING	PASSES

## TROUBLE SHOOTING GUIDE

ITEM	PROBLEM	PROBABLE REASONS	CORRECTIVE ACTIONS
One piece Closet	1. Water not coming in bowl area while flushing	Water line not cleaned properly	Before installation clean the incoming as well as out going line
		Malfunctioning of Mechanism inside tank	Change the mechanism
		No water in the flush tank	Raise the height change slot to the max. level
	2. Leaking of water in bowl area	Push button is locked	Release the push button
Fitment of mechanism end part and outlet of tank not fitted properly		After opening the mechanism check the fitment	
Wall hung water closet	1. Water not coming in bowl area while flushing	Malfunctioning of Mechanism inside tank	Change the mechanism
		Height change slot adjusted at lower level	Closet is not levelled properly
	2. Leaking of water in bowl area	Raise the height change slot to the max. level	Level the closet properly
	3. Insufficient Water quantity for effective flushing	Flush valve /concealed cistern is not working properly	Change flush valve / concealed cistern
Wash Basin/ Table Top	1. Water not coming in bowl area while flushing	Flush pipe is not inserted up to the end of inlet hole	Insert the flush pipe upto the end of inlet
		Closet is not levelled	Level the closet properly
	2. Leaking of water in bowl area	Connection between closet outlet and drainage pipe is improper	Engage experienced plumber for proper connection
EWC/Pan/ Anglo indian	1. Overflow chocked and foul smell	Full threaded waste coupling might be in use	Replace it by slot cut coupling
	2. Water logging in platform and bowl area	Bracket and basin fixing may be the reason	Levelling to be checked and rectified
	3. No tap hole in the basin	Tap hole is semi punched from back side	Call plumber and open up the semi punched hole
EWC/Pan/ Anglo indian	1. Water not coming in bowl area while flushing	Flush bend is not inserted up to the end of inlet hole	Insert the flush pipe upto the end of inlet
		Levelling issue	To be levelled properly